

R&S®FSW MSRA

Multi-Standard Radio Analyzer

User Manual

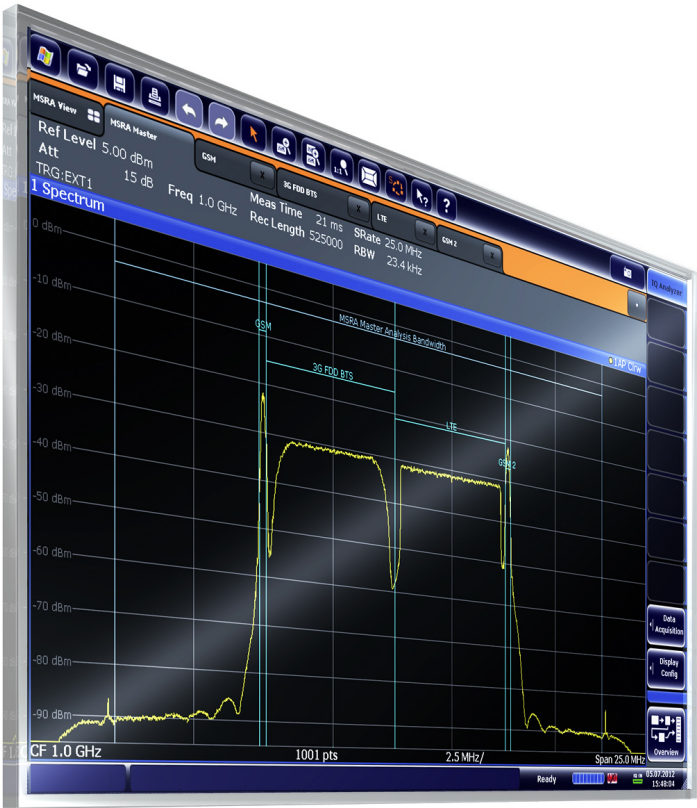

1175.6455.02 – 10

This manual applies to the following R&S®FSW models with firmware version 2.00 and higher:

- R&S®FSW8 (1312.8000K08)
- R&S®FSW13 (1312.8000K13)
- R&S®FSW26 (1312.8000K26)
- R&S®FSW43 (1312.8000K43)
- R&S®FSW50 (1312.8000K50)
- R&S®FSW67 (1312.8000K67)

The firmware of the instrument makes use of several valuable open source software packages. For information, see the "Open Source Acknowledgement" on the user documentation CD-ROM (included in delivery).

Rohde & Schwarz would like to thank the open source community for their valuable contribution to embedded computing.

© 2014 Rohde & Schwarz GmbH & Co. KG

Mühldorfstr. 15, 81671 München, Germany

Phone: +49 89 41 29 - 0

Fax: +49 89 41 29 12 164

E-mail: info@rohde-schwarz.com

Internet: www.rohde-schwarz.com

Subject to change – Data without tolerance limits is not binding.

R&S® is a registered trademark of Rohde & Schwarz GmbH & Co. KG.

Trade names are trademarks of the owners.

The following abbreviations are used throughout this manual: R&S®FSW is abbreviated as R&S FSW. R&S®FSW Multi-Standard Radio Analyzer is abbreviated as R&S FSW MSRA.

Contents

1	Preface	5
1.1	About this Manual.....	5
1.2	Documentation Overview.....	6
1.3	Conventions Used in the Documentation.....	7
2	Welcome to the MSRA Operating Mode	9
2.1	Starting the MSRA operating mode.....	9
2.2	Understanding the Display Information.....	10
3	Typical Applications	16
4	Measurements and Result Displays	17
5	Applications and Operating Modes	19
5.1	Available Applications.....	20
5.2	Selecting the Operating Mode and Application.....	23
5.3	Using the Sequencer in MSRA Mode.....	24
6	MSRA Basics	26
6.1	Configuration.....	26
6.2	Data Acquisition.....	27
6.3	Multi-Standard Analysis.....	28
6.4	Restrictions for Applications.....	29
6.5	Measurements in the Time and Frequency Domain.....	30
7	Configuration	32
7.1	Default Settings for MSRA Measurements.....	33
7.2	Configuration Overview.....	34
7.3	Input Source Settings.....	35
7.4	Amplitude.....	43
7.5	Frequency Settings.....	49
7.6	Trigger Settings.....	51
7.7	Data Acquisition and Bandwidth Settings.....	57
7.8	Output Settings.....	65
7.9	Display Configuration.....	67

7.10	Automatic Settings.....	67
8	Analysis.....	70
8.1	Configuring the Analysis Line.....	70
9	How to Perform Measurements in MSRA Mode.....	72
10	Measurement Example: Analyzing MSR Signals.....	75
11	Remote Commands to Perform Measurements in MSRA Mode.....	83
11.1	Introduction.....	83
11.2	Common Suffixes.....	88
11.3	Activating MSRA Measurements.....	89
11.4	Configuring MSRA Measurements.....	94
11.5	Capturing Data and Performing Sweeps.....	132
11.6	Retrieving Results.....	137
11.7	Querying the Status Registers.....	141
11.8	Analyzing MSRA Measurements.....	144
11.9	Commands Specific to MSRA Applications.....	144
11.10	Programming Example: Analyzing MSR Signals.....	147
A	Annex.....	149
A.1	Reference: Format Description for I/Q Data Files.....	149
A.2	Formats for Returned Values: ASCII Format and Binary Format.....	150
A.3	Sample Rate and Maximum Usable I/Q Bandwidth for RF Input.....	150
A.4	Sample Rates and Bandwidths for Digital I/Q Data.....	157
	List of Remote Commands (MSRA).....	159
	Index.....	162

1 Preface

1.1 About this Manual

This R&S FSW MSRA User Manual provides all the information **specific to the operating mode**. All general instrument functions and settings common to all applications and operating modes are described in the main R&S FSW User Manual.

The main focus in this manual is on the measurement results and the tasks required to obtain them. The following topics are included:

- **Welcome to the MSRA Operating Mode**
Introduction to and getting familiar with the operating mode
- **Typical Applications**
Example measurement scenarios in which the operating mode is frequently used
- **Measurements and Result Displays**
Details on supported measurements and their result types
- **MSRA Basics**
Background information on basic terms and principles in the context of the MSRA operating mode
- **MSRA Configuration**
A concise description of all functions and settings available to configure an MSRA measurements with their corresponding remote control command
- **How to Perform Measurements in MSRA Mode**
The basic procedure to perform an MSRA measurement with step-by-step instructions
- **Measurement Examples**
Detailed measurement examples to guide you through typical measurement scenarios and allow you to try out the operating mode immediately
- **Optimizing and Troubleshooting the Measurement**
Hints and tips on how to handle errors and optimize the test setup
- **Remote Commands for MSRA Measurements**
Remote commands required to configure and perform MSRA measurements in a remote environment, sorted by tasks
(Commands required to set up the environment or to perform common tasks on the instrument are provided in the main R&S FSW User Manual)
Programming examples demonstrate the use of many commands and can usually be executed directly for test purposes
- **Annex**
Reference material
- **List of remote commands**
Alphabetic list of all remote commands described in the manual
- **Index**

1.2 Documentation Overview

The user documentation for the R&S FSW consists of the following parts:

- Printed Getting Started manual
- Online Help system on the instrument
- Documentation CD-ROM with:
 - Getting Started
 - User Manuals for base unit and firmware applications
 - Service Manual
 - Release Notes
 - Data sheet and product brochures

Online Help

The Online Help is embedded in the instrument's firmware. It offers quick, context-sensitive access to the complete information needed for operation and programming. Online help is available using the  icon on the toolbar of the R&S FSW.

Web Help

The web help provides online access to the complete information on operating the R&S FSW and all available options, without downloading. The content of the web help corresponds to the user manuals for the latest product version. The web help is available from the R&S FSW product page at <http://www.rohde-schwarz.com/product/FSW.html> > Downloads > Web Help.

Getting Started

This manual is delivered with the instrument in printed form and in PDF format on the CD. It provides the information needed to set up and start working with the instrument. Basic operations and handling are described. Safety information is also included.

The Getting Started manual in various languages is also available for download from the Rohde & Schwarz website, on the R&S FSW product page at <http://www2.rohde-schwarz.com/product/FSW.html>.

User Manuals

User manuals are provided for the base unit and each additional (firmware) application.

The user manuals are available in PDF format - in printable form - on the Documentation CD-ROM delivered with the instrument. In the user manuals, all instrument functions are described in detail. Furthermore, they provide a complete description of the remote control commands with programming examples.

The user manual for the base unit provides basic information on operating the R&S FSW in general, and the Spectrum application in particular. Furthermore, the software functions that enhance the basic functionality for various applications are described here. An introduction to remote control is provided, as well as information on maintenance, instrument interfaces and troubleshooting.

In the individual application manuals, the specific instrument functions of the application are described in detail. For additional information on default settings and parameters, refer to the data sheets. Basic information on operating the R&S FSW is not included in the application manuals.

All user manuals are also available for download from the Rohde & Schwarz website, on the R&S FSW product page at <http://www2.rohde-schwarz.com/product/FSW.html>.

Service Manual

This manual is available in PDF format on the Documentation CD-ROM delivered with the instrument. It describes how to check compliance with rated specifications, instrument function, repair, troubleshooting and fault elimination. It contains all information required for repairing the R&S FSW by replacing modules.

Release Notes

The release notes describe the installation of the firmware, new and modified functions, eliminated problems, and last minute changes to the documentation. The corresponding firmware version is indicated on the title page of the release notes.

The most recent release notes are also available for download from the Rohde & Schwarz website, on the R&S FSW product page at <http://www2.rohde-schwarz.com/product/FSW.html> > Downloads > Firmware.

1.3 Conventions Used in the Documentation

1.3.1 Typographical Conventions

The following text markers are used throughout this documentation:

Convention	Description
"Graphical user interface elements"	All names of graphical user interface elements on the screen, such as dialog boxes, menus, options, buttons, and softkeys are enclosed by quotation marks.
KEYS	Key names are written in capital letters.
File names, commands, program code	File names, commands, coding samples and screen output are distinguished by their font.
<i>Input</i>	Input to be entered by the user is displayed in italics.
Links	Links that you can click are displayed in blue font.
"References"	References to other parts of the documentation are enclosed by quotation marks.

1.3.2 Conventions for Procedure Descriptions

When describing how to operate the instrument, several alternative methods may be available to perform the same task. In this case, the procedure using the touchscreen is described. Any elements that can be activated by touching can also be clicked using an additionally connected mouse. The alternative procedure using the keys on the instrument or the on-screen keyboard is only described if it deviates from the standard operating procedures.

The term "select" may refer to any of the described methods, i.e. using a finger on the touchscreen, a mouse pointer in the display, or a key on the instrument or on a keyboard.

2 Welcome to the MSRA Operating Mode

The MSRA operating mode is part of the standard R&S FSW firmware and adds functionality to perform multi-standard radio analysis.

The R&S FSW MSRA operating mode features:

- analysis of the same I/Q data in more than one application
- analysis of correlated effects due to multiple standards
- configuration of data acquisition settings only required once for all applications
- overview of all results in one screen in addition to large display of individual results
- common analysis line (time marker) across all applications
- performing measurements in the frequency and time domain (such as channel power measurements) on I/Q data

This user manual contains a description of the functionality specific to the MSRA operating mode, including remote control operation.

All functions not discussed in this manual are the same as in Signal and Spectrum Analyzer mode and are described in the R&S FSW User Manual. The latest version is available for download at the product homepage

<http://www2.rohde-schwarz.com/product/FSW.html>.

2.1 Starting the MSRA operating mode

MSRA is a new operating mode on the R&S FSW.

To activate the MSRA operating mode

1. Press the MODE key on the front panel of the R&S FSW.
A dialog box opens that contains all operating modes and applications currently available on your R&S FSW.
2. Select the "Multi Standard Radio Analyzer" tab.



3. Confirm the message informing you that you are changing operating modes.
The R&S FSW closes all active measurement channels in the current operating mode, then opens a new measurement channel for the MSRA operating mode.
In addition to the "MSRA View", an "MSRA Master" tab is displayed.

The Sequencer is automatically activated in continuous mode (see [chapter 5.3, "Using the Sequencer in MSRA Mode"](#), on page 24), starting an I/Q Analyzer data acquisition with the default settings (but with a "Spectrum" result display). It can be configured in the MSRA "Overview" dialog box, which is displayed when you select the "Overview" softkey from any menu (see [chapter 7, "Configuration"](#), on page 32).



Remote command:

INST:MODE MSR, see [INSTrument:MODE](#) on page 91

2.2 Understanding the Display Information

The following figure shows a screen display during MSRA operation. All different information areas are labeled. They are explained in more detail in the following sections.



- The orange background of the screen behind the measurement channel tabs indicates that you are in MSRA operating mode.
- The  icon on the tab label indicates that the displayed trace (e.g. in an MSRA application) no longer matches the currently captured data. This may be the case, for example, if a data acquisition was performed in another application. As soon as the result display is refreshed, the icon disappears.
- The  icon indicates that an error or warning is available for that measurement channel. This is particularly useful if the MSRA View tab is displayed.

An orange "IQ" indicates that the results displayed in the MSRA application(s) no longer match the data captured by the MSRA Master. The "IQ" disappears after the results in the application(s) are refreshed.

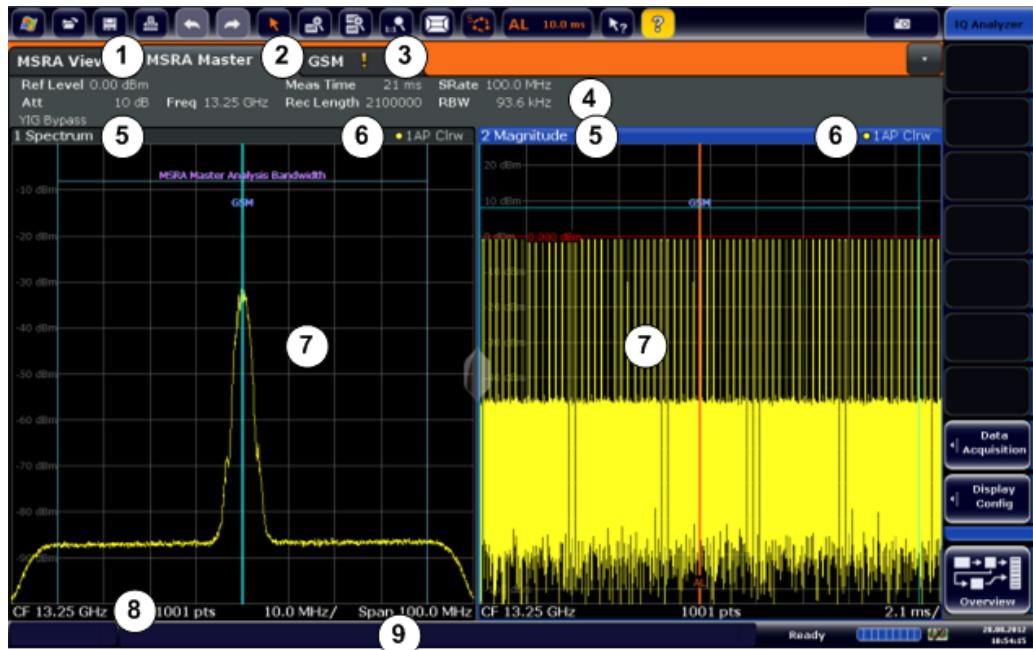

- 1 = MSRA View (overview of all active channels in MSRA mode)
- 2 = MSRA Master (data acquisition channel with global configuration settings)
- 3 = Measurement channel tab for individual MSRA application
- 4 = Channel bar for firmware and measurement settings of current application
- 5+6 = Window title bar with diagram-specific (trace) information and analysis interval (applications)
- 7 = Diagram area
- 8 = Diagram footer with diagram-specific information, depending on evaluation
- 9 = Instrument status bar with error messages, progress bar and date/time display

The diagram area varies depending on the type of measurement channel, as described in detail in the following topics.

Window title bar information

For each diagram, the header provides the following information:



Fig. 2-1: Window title bar information in MSRA mode

- 1 = Window number
- 2 = Window type
- 3 = Trace color
- 4 = Trace number
- 5 = Detector
- 6 = Trace mode
- 7 = Analysis interval
- 8 = Analysis line indication

Diagram footer information

The information in the diagram footer (beneath the diagram) depends on the evaluation:

- Center frequency
- Number of sweep points
- Range per division (x-axis)
- Span (Spectrum)

Status bar information

Global instrument settings, the instrument status and any irregularities are indicated in the status bar beneath the diagram. Furthermore, the progress of the current operation is displayed in the status bar.



If an error or warning is available for a measurement channel, the  icon is displayed next to the tab label in the channel bar.

2.2.1 MSRA View

The MSRA View is an overview of all active channels in MSRA mode, similar to the MultiView tab in Signal and Spectrum Analyzer mode. At the top of the screen the MSRA Master is displayed, i.e. the application that captures data. Beneath the MSRA Master, all active applications are displayed in individual windows. Each application has its own channel bar with the current settings as well as a button in order to switch to that application tab directly.

The MSRA View displays the following basic elements:

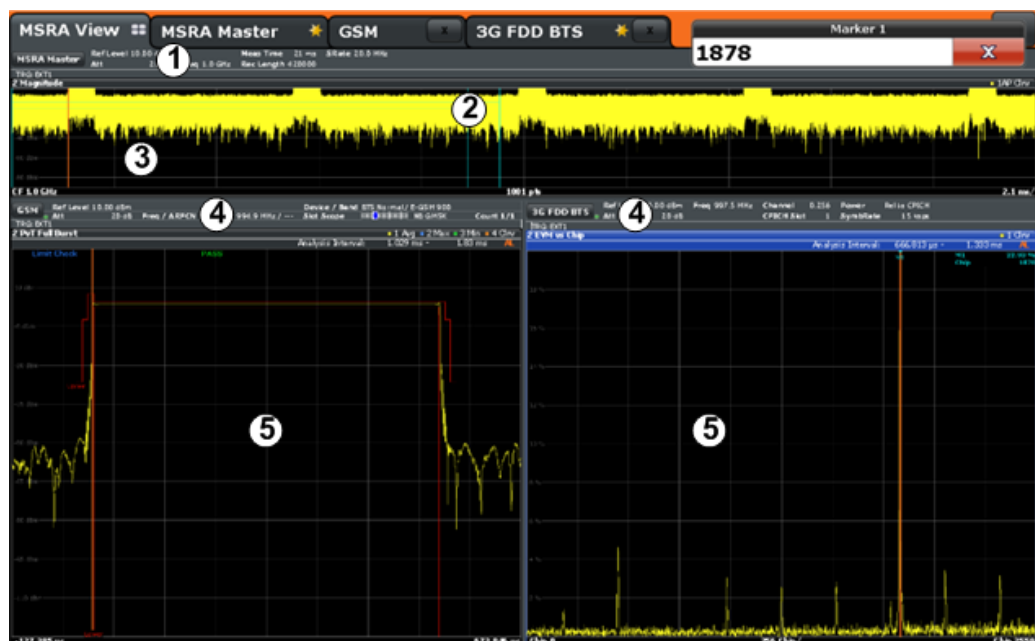

- 1 = Channel information bar for the MSRA Master
- 2 = Application data coverage for each active application
- 3 = Result display for MSRA Master (for entire capture buffer)
- 4 = Channel information bar for application with button to switch to application tab
- 5 = Result display for application (for analysis interval)

2.2.2 MSRA Master

The MSRA Master is the only channel that captures data. It also controls global configuration settings for all applications. The MSRA Master channel itself is implemented as an I/Q Analyzer application. The MSRA Master measurement channel cannot be deleted or replaced.

The following figure shows the screen elements specific to the MSRA Master.

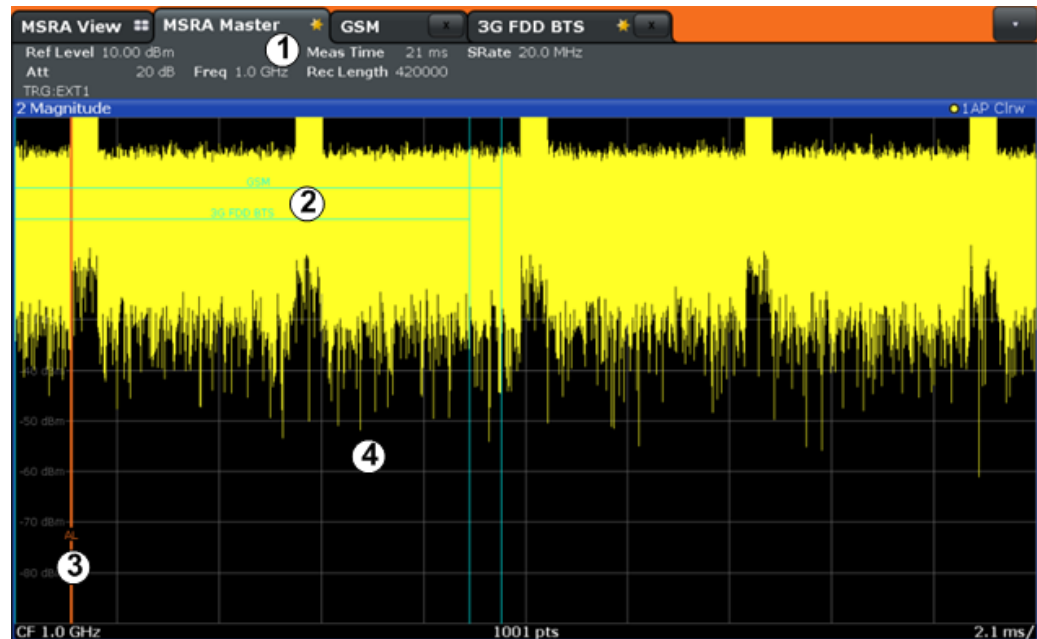

- 1 = Channel information bar for the MSRA Master
- 2 = Data coverage for each active application
- 3 = Analysis line
- 4 = Result display for MSRA Master (for entire capture buffer)

Channel bar information

The channel bar shows the firmware and measurement information for data acquisition and global configuration.

Table 2-1: Information displayed in the channel bar for the MSRA Master

Ref Level	Reference level
(m.+el.)Att	(Mechanical and electronic) RF attenuation
Ref Offset	Reference level offset
Freq	Center frequency
AQT	Defined measurement time, i.e. the duration of data acquisition to the capture buffer
Rec Length	Defined record length (number of samples to capture)
SRate	Defined sample rate for data acquisition
RBW	(Spectrum evaluation only) Resolution bandwidth calculated from the sample rate and record length

In addition, the channel bar also displays information on instrument settings that affect the measurement results even though this is not immediately apparent from the display of the measured values (e.g. transducer or trigger settings). This information is displayed only when applicable for the current measurement. For details see the R&S FSW Getting Started manual.

Data coverage for each active application

Each application obtains an extract of the data captured by the MSRA Master (see also [chapter 6.3, "Multi-Standard Analysis"](#), on page 28). Generally, if a signal contains data channels for multiple standards, the individual applications are used to analyze the channel for the corresponding standard. Thus, it is of interest to know which application is analyzing which part of the captured data, or more precisely, which data channel. The MSRA Master display indicates the data covered by each application, restricted to the channel bandwidth used by the corresponding standard, by vertical blue lines labeled with the application name. For applications that support several standards (e.g. VSA, LTE) an estimated or user-defined bandwidth is indicated.

2.2.3 MSRA Applications

The data captured by the MSRA Master measurement (or only parts of it) can be evaluated by various applications. The measurement channel for each application contains the settings and results for the application data extract from the capture buffer.

The following figure shows the screen elements specific to the MSRA application tabs.

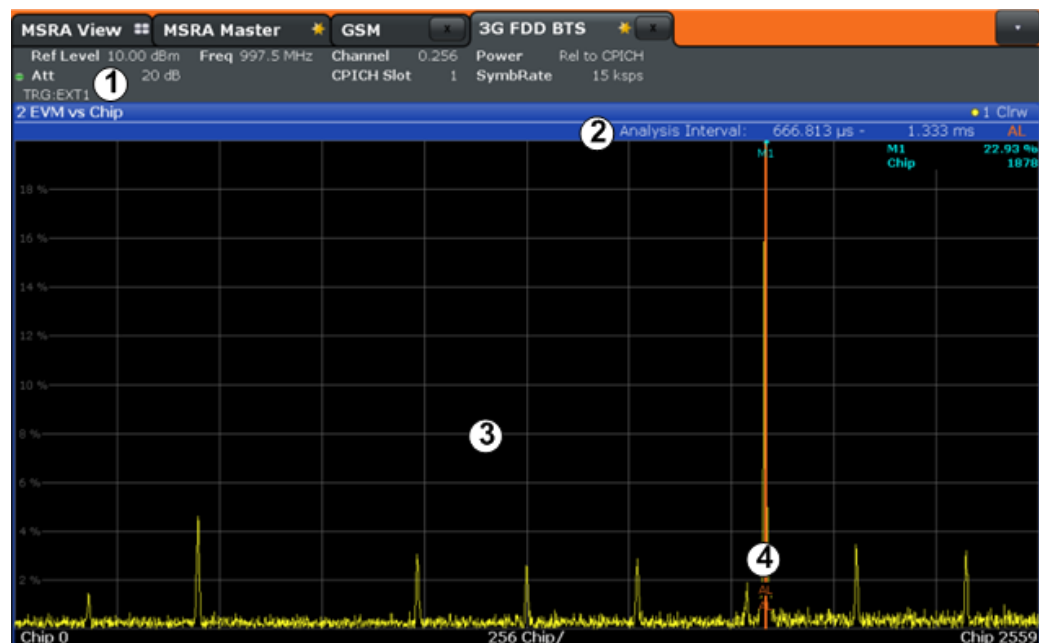

- 1 = Channel information bar for application
- 2 = Analysis interval for current evaluation
- 3 = Result display for analysis interval
- 4 = Analysis line

The display for the individual MSRA applications is identical to the display in Signal and Spectrum Analyzer mode except for the following differences:

- The analysis interval indicates which part of the capture buffer is being evaluated and displayed in each window.
- The acquisition time indicated in the channel bar (Meas Time) indicates the *analyzed* measurement time, not the captured time.
- Any bandwidth or sample rate values refer to the application data, not to the actual data acquisition from the input signal.
- The analysis line for time-based displays is only available in MSRA mode. It represents a common time marker in all applications whose analysis interval includes that time (see "[Analysis line](#)" on page 29).

For details on the individual application displays see the corresponding User Manuals for those applications.

3 Typical Applications

The technological advances made in the field of mobile radio have given rise to a wide variety of standards over the past several decades. These standards, which include those produced by the global cooperative for standardization – the 3rd Generation Partnership Project (3GPP) – are based on various transmission technologies. Network operators can deploy GSM/EDGE, WCDMA, TD-SCDMA and LTE or combinations of these four standards.

To handle these complex scenarios, the Multistandard Radio Base Station (MSR-BS) was developed. These can transmit and receive multiple standards simultaneously on various carriers. An MSR-BS combines at least two different radio access technologies (RAT).

Specifications and Tests

3GPP has published the specifications TS 37.141 and TS 37.104 for multistandard base stations. The latter describes the minimum requirements for multistandard base stations in terms of RF requirements for the downlink and uplink. TS 37.141 defines the tests and test requirements for the MSR-BS based on these RF requirements.

To allow for efficient MSR-BS testing, TS 37.141 includes test configurations. The goal of these test configurations is to significantly reduce the complexity of the many possible test scenarios. They are limited to the worst-case scenarios with the strictest criteria. Thus, for example, a test configuration is provided for receiver tests in which two signals – a GSM carrier and an LTE carrier with a $BW_{\text{Channel}} = 5 \text{ MHz}$ – are positioned at the lower and upper edge of BW_{RF} while maintaining $F_{\text{offset-RAT}}$. This allows receiver tests to be performed with a configuration that fully utilizes the maximum bandwidth BW_{RF} of the MSR-BS.

MSR-BS Testing using R&S FSW Multi-Standard Radio Analysis

The newly introduced R&S FSW MSRA mode allows you to capture signals from a multistandard base station and analyze the same data in various standard applications.

4 Measurements and Result Displays

MSRA measurement

The only true measurement in MSRA mode in which I/Q data from the input signal is captured and stored is performed by the MSRA Master. This data acquisition is performed as in the I/Q Analyzer application, i.e. a specified frequency span of the input signal is swept for a specified measurement time. The captured I/Q data can then be analyzed in various different applications.

Result displays

The data that was captured by the MSRA Master can be evaluated in various different applications. All evaluation modes available for the MSRA applications are displayed in the selection bar in SmartGrid mode.



For details on working with the SmartGrid see the R&S FSW Getting Started manual.

The result displays available in MSRA mode are those described for the individual applications. The MSRA Master is implemented as an I/Q Analyzer application and has the same result displays.

See the R&S FSW I/Q Analyzer User Manual for a description of the result displays available for the I/Q Analyzer and thus the MSRA Master.

Measurements in the time and frequency domain

The I/Q Analyzer application (*not Master*) in MSRA mode can also perform measurements on the captured I/Q data in the time and frequency domain (see also [chapter 6.5, "Measurements in the Time and Frequency Domain"](#), on page 30).

This allows you to perform standard-specific and general power measurements (such as ACLR or SEM) or statistical evaluations, as well as analyzing the EVM or modulation accuracy, on the same captured I/Q data.



Time and frequency-based measurements are configured using the same settings and provide similar results as in the Spectrum application. In addition, the analysis interval used for the measurement is indicated as in all MSRA applications.

The time and frequency domain measurements and the available results are described in detail in the R&S FSW User Manual.

5 Applications and Operating Modes

The R&S FSW provides several applications for different analysis tasks and different types of signals, e.g. W-CDMA, I/Q analysis or basic spectrum analysis. When you activate an application, a new measurement channel is created which determines the measurement settings for that application. The same application can be activated with different measurement settings by creating several channels for the same application. Each channel is displayed in a separate tab on the screen.



The maximum number may be limited further by the available memory on the instrument.

Independent vs correlating measurements

With the **conventional R&S FSW Signal and Spectrum Analyzer** you can perform several different measurements almost simultaneously. However, the individual measurements are independent of each other - **each application captures and evaluates its own set of data**, regardless of what the other applications do.

In some cases it may be useful to **analyze the exact same input data using different applications**. For example, imagine capturing data from a base station and analyzing the RF spectrum in the Analog Demodulation application. If a spur or an unexpected peak occurs, you may want to analyze the same data in the I/Q Analyzer to see the real and imaginary components of the signal and thus detect the reason for the irregular signal. Normally when you switch to a different application, evaluation is performed on the data that was captured by that application, and not the previous one. In our example that would mean the irregular signal would be lost. Therefore, a second operating mode is available in the R&S FSW: Multi-Standard Radio Analyzer (MSRA) mode.

Multi-Standard Radio Analyzer mode

In **Multi-Standard Radio Analyzer (MSRA) mode**, data acquisition is performed once as an I/Q measurement, and the captured data is then evaluated by any number of applications for different radio standards. Data acquisition and global configuration settings are controlled globally, while the evaluation and display settings can be configured individually for each application. Using the Multi-Standard Radio Analyzer, unwanted correlations between different signal components using different transmission standards can be detected. Thus, for example, an irregularity in a GSM burst can be examined closer in the R&S FSW 3G FDD BTS (W-CDMA) application to reveal dependencies like a change in the EVM value.

Multi-Standard Realtime mode

In order to combine the advantages of the MSRA mode with its correlated measurements and the gapless results provided by realtime measurements, a third operating mode has been introduced: the **Multi-Standard Realtime (MSRT) mode**. This operating mode is only available if one of the realtime options (R&S FSW-K85R/-U85R/-K160R/-U160R) is installed.

In this operating mode, data acquisition is performed once as a realtime measurement, and the captured data is then evaluated by any number of applications. Thus, a real-time measurement triggered with a frequency mask can be performed, and the results can be evaluated in the VSA application, for example, to detect the cause of a frequency exception.

Distinct operating modes

Although the applications themselves are identical in all operating modes, the handling of the data between applications is not. Thus, the operating mode determines which applications are available and active. Whenever you change the operating mode, the currently active measurement channels are closed. The default operating mode is Signal and Spectrum Analyzer mode; however, the presetting can be changed.

Remote command:

INST:MODE MSR, see [INSTrument:MODE](#) on page 91

Switching between applications

When you switch to a new application, a set of parameters is passed on from the current application to the new one:

- center frequency and frequency offset
- reference level and reference level offset
- attenuation

After initial setup, the parameters for the measurement channel are stored upon exiting and restored upon re-entering the channel. Thus, you can switch between applications quickly and easily.

5.1 Available Applications

The R&S FSW provides some applications in the base unit while others are available only if the corresponding firmware options are installed.

Currently, only applications for **base-station** tests and those that process I/Q data are supported in MSRA mode, in particular:

- I/Q Analyzer
- Analog Demodulation
- Pulse measurements
- GSM
- Transient Analysis
- 3G FDD BTS
- cdma2000 BTS
- 1xEV-DO BTS
- Vector Signal Analysis (VSA)

• LTE (Downlink)	
I/Q Analyzer.....	21
Analog Demodulation.....	21
Pulse Measurements.....	21
GSM.....	21
Transient Analysis.....	22
Vector Signal Analysis (VSA).....	22
3G FDD BTS.....	22
TD-SCDMA BTS.....	22
cdma2000 BTS.....	22
1xEV-DO BTS.....	23
LTE DL.....	23

I/Q Analyzer

The I/Q Analyzer application provides measurement and display functions for digital I/Q signals. Evaluation of the captured I/Q data in the frequency and time domain is also possible.

For details see the R&S FSW I/Q Analyzer User Manual.

Remote command:

INST:SEL IQ, see INSTRUMENT[:SELEct] on page 92

Analog Demodulation

The Analog Demodulation application requires an instrument equipped with the corresponding optional software. This application provides measurement functions for demodulating AM, FM, or PM signals.

For details see the R&S FSW Analog Demodulation User Manual.

Remote command:

INST:SEL ADEM, see INSTRUMENT[:SELEct] on page 92

Pulse Measurements

The Pulse application requires an instrument equipped with the Pulse Measurements option, R&S FSW-K6. This application provides measurement functions for pulsed signals.

For details see the R&S FSW-K6 User Manual.

Remote command:

INST:SEL PULSE, see INSTRUMENT[:SELEct] on page 92

GSM

The GSM application requires an instrument equipped with the corresponding optional software. This application provides measurement functions for measuring GSM signals.

For details see the R&S FSW GSM User Manual.

Remote command:

INST:SEL GSM, see INSTRUMENT[:SELEct] on page 92

Transient Analysis

The Transient Analysis application requires an instrument equipped with the Transient Analysis option, R&S FSW-K60. This application provides measurements and evaluations for Transient Analysis.

For details see the R&S FSW-K60 User Manual.

Remote command:

INST:SEL TA, see [INSTrument\[:SElect\]](#) on page 92

Vector Signal Analysis (VSA)

The VSA application requires an instrument equipped with the Vector Signal Analysis option, R&S FSW-K70. This application provides measurements and evaluations for Vector Signal Analysis.

For details see the R&S FSW VSA User Manual.

Remote command:

INST:SEL DDEM, see [INSTrument\[:SElect\]](#) on page 92

3G FDD BTS

The 3G FDD BTS application requires an instrument equipped with the 3GPP Base Station Measurements option, R&S FSW-K72. This application provides test measurements for WCDMA downlink signals (base station signals) according to the test specification.

RF measurements are not supported in MSRA mode.

For details see the R&S FSW 3G FDD User Manual.

Remote command:

INST:SEL BWCD, see [INSTrument\[:SElect\]](#) on page 92

TD-SCDMA BTS

The TD-SCDMA BTS application requires an instrument equipped with the TD-SCDMA BTS Measurements option, R&S FSW-K82. This application provides test measurements for TD-SCDMA BTS downlink signals (base station signals) according to the test specification.

RF measurements are not supported in MSRA mode.

For details see the R&S FSW TD-SCDMA User Manual.

Remote command:

INST:SEL BTDS, see [INSTrument\[:SElect\]](#) on page 92

cdma2000 BTS

The cdma2000 BTS application requires an instrument equipped with the cdma2000 BTS Measurements option, R&S FSW-K82. This application provides test measurements for cdma2000 BTS downlink signals (base station signals) according to the test specification.

RF measurements are not supported in MSRA mode.

For details see the R&S FSW cdma2000 User Manual.

Remote command:

INST:SEL BC2K, see [INSTrument\[:SElect\]](#) on page 92

1xEV-DO BTS

The 1xEV-DO BTS application requires an instrument equipped with the 1xEV-DO BTS Measurements option, R&S FSW-K84. This application provides test measurements for 1xEV-DO BTS downlink signals (base station signals) according to the test specification.

RF measurements are not supported in MSRA mode.

For details see the R&S FSW 1xEV-DO User Manual.

Remote command:

INST:SEL BDO, see [INSTrument\[:SElect\]](#) on page 92

LTE DL

The LTE Downlink application requires an instrument equipped with the LTE Downlink option, R&S FSW-K100 or R&S FSW-K104. This application provides test measurements for LTE downlink signals (base station signals) according to the test specification.

Frequency sweep measurements are not supported in MSRA mode.

For details see the R&S FSW LTE DL User Manual.

Remote command:

INST:SEL LTE, see [INSTrument\[:SElect\]](#) on page 92

5.2 Selecting the Operating Mode and Application

The default operating mode is Signal and Spectrum Analyzer mode, however, the pre-setting can be changed.

(See the "Instrument Setup" chapter in the R&S FSW User Manual).

Both the operating mode and the application can be selected in the "Mode" dialog box which is displayed when you press the MODE key.

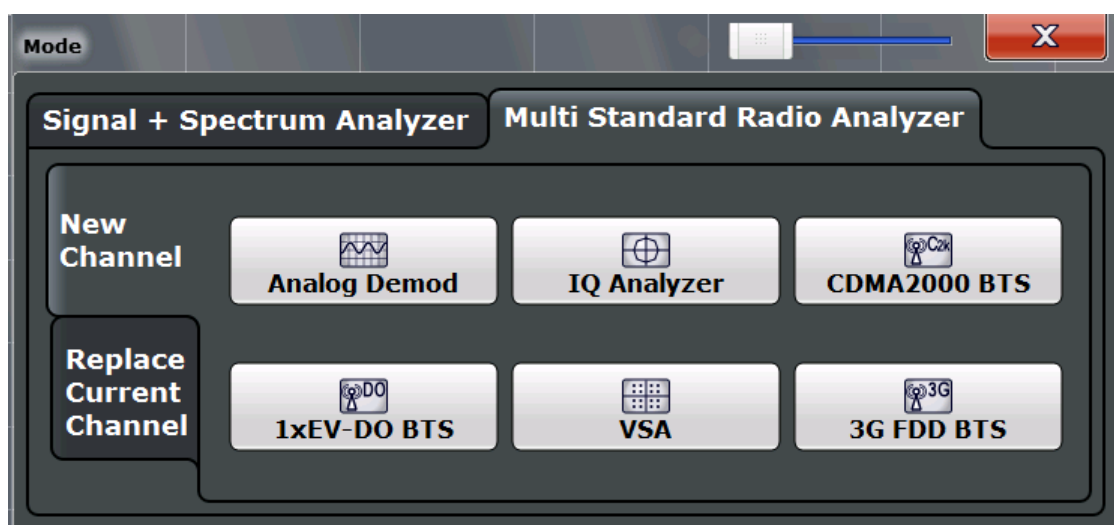

To switch the operating mode, select the corresponding tab (see [chapter 2.1, "Starting the MSRA operating mode"](#), on page 9).

To select an application, select the corresponding button.



To deactivate a channel, simply close the corresponding tab.

The remote commands required to perform these tasks are described in [chapter 11.3, "Activating MSRA Measurements"](#), on page 89.

New Channel	24
Replace Current Channel	24

New Channel

The applications selected on this tab are started in a new channel, i.e. a new tab in the display.

Remote command:

`INSTRument:CREate[:NEW]` on page 89

`INSTRument[:SElect]` on page 92

Replace Current Channel

The applications selected on this tab are started in the currently displayed channel, replacing the current application.

Remote command:

`INSTRument:CREate:REPLace` on page 90

5.3 Using the Sequencer in MSRA Mode

When you switch to MSRA mode, the Sequencer is automatically activated in continuous mode. Unless it is stopped or you select a different Sequencer mode, the R&S FSW will continuously perform a data acquisition (MSRA Master), then evaluate the data in the active applications one after the other, then repeat the data acquisition and evaluate the new data etc. The tabs are updated after each measurement or evaluation. This behaviour is identical to Signal and Spectrum Analyzer mode (also for Single Sequence or Channel-Defined Sequence modes).

However, if you switch the Sequencer off, the behaviour of the sweep functions is slightly different to Signal and Spectrum Analyzer mode (see also ["Performing sweeps"](#) on page 27):

- If continuous sweep is active (default) and you switch to a different application, continuous sweep is aborted. This is necessary in order to evaluate the same data in different applications without overwriting the data in the capture buffer. Continuous sweep can be started again as usual.
- Only the application that is currently displayed when a measurement is performed is updated automatically. A new "Refresh" function is available to update the display in one or all other applications.

For details on the Sequencer function see the R&S FSW User Manual.



The "Sequencer" menu is available from the toolbar.

Sequencer State

Activates or deactivates the Sequencer. If activated, sequential operation according to the selected Sequencer mode is started immediately.

Remote command:

`SYSTem:SEQuencer` on page 137

`INITiate:SEQuencer:IMMediate` on page 135

`INITiate:SEQuencer:ABORt` on page 134

Sequencer Mode

Defines how often which measurements are performed. The currently selected mode softkey is highlighted blue. During an active Sequencer process, the selected mode softkey is highlighted orange.

"Single Sequence"

Each measurement is performed once, until all measurements in all active channels have been performed.

"Continuous Sequence"

The measurements in each active channel are performed one after the other, repeatedly, in the same order, until sequential operation is stopped.

This is the default Sequencer mode.

"Channel-defined Sequence"

First, a single sequence is performed. Then, only channels in continuous sweep mode are repeated.

Remote command:

`INITiate:SEQuencer:MODE` on page 135

Refresh All

This function is only available if the Sequencer is deactivated, no sweep is currently running, and only in MSRA or MSRT mode.

The data in the capture buffer is re-evaluated by all active applications, for example after a new sweep was performed while the Sequencer was off.

Note: To update only the displays in the currently active application, use the "Refresh" function in the "Sweep" menu for that application (see "Refresh" on page 63).

For details on the MSRA operating mode see the R&S FSW MSRA User Manual.

For details on the MSRT operating mode see the R&S FSW MSRA User Manual.

Remote command:

`INITiate:SEQuencer:REFResh[:ALL]` on page 136

6 MSRA Basics

Some background knowledge on basic terms and principles used in MSRA operating mode is provided here for a better understanding of the required configuration settings.

6.1 Configuration

Master parameters

In MSRA mode, only the MSRA Master performs a data acquisition. Thus, all parameters that determine how the I/Q data is captured from the I/Q channel can only be configured in the MSRA Master tab. In all application tabs, these settings are deactivated (or have a different meaning).

Typical master parameters include:

- Sample rate
- Record length
- Bandwidth
- Center frequency
- Reference level
- Trigger settings
- External reference
- Impedance, preamplification, attenuation

Channel-specific parameters

Each application, however, can define all parameters concerning analysis individually.

Typical channel-specific parameters include:

- Center frequency, duration and number of trace points for the application data extract
- Offset of the application data extract from the trigger event
- Evaluation methods
- Range and scaling
- Trace mode
- Marker positions

Conflicting parameters

Master and channel-specific parameters can be configured independently of one another, in any order that is convenient to you. However, there are dependencies between the parameters, as the applications can only evaluate data that has been captured by the MSRA Master previously. Thus, configuring parameters is not restricted,

but you are informed about the violation of possible restrictions by error messages in the status bar of the applications where necessary.

6.2 Data Acquisition

As mentioned before, only the MSRA Master performs a data acquisition. Thus, the MSRA Master defines the center frequency, sample rate and record length of the captured I/Q data. It also defines the trigger event, thus all applications have the same trigger. However, an offset from the trigger can be defined by the individual applications (see ["Trigger offset vs. capture offset"](#) on page 29).

Performing sweeps

When you switch to MSRA mode, the Sequencer is automatically activated in continuous mode. The MSRA Master continuously performs a data acquisition. If any applications are activated, then after each measurement, the data in the active applications is evaluated one after the other. The MSRA Master will then repeat the data acquisition and evaluate the new data etc. The channel displays are updated after each measurement or evaluation.

Alternatively, you can perform measurements manually. You can start a single or continuous sweep from any application, which updates the data in the capture buffer and the results in the current application. The results in the other applications, however, remain unchanged. You must refresh them manually, either individually or all at once, using a **"Refresh"** function.

Note that in **continuous sweep mode**, sweeping is aborted when you switch to a different application. You can then continue sweeping from there. This is necessary in order to evaluate the same data in different applications without overwriting the data in the capture buffer.

In **single sweep mode**, only one sweep is performed; a sweep count is not available - neither for the MSRA Master, nor for the applications. However, depending on the application, a statistics count may be available for statistics based on a single data acquisition. Trace averaging is performed as usual for sweep count = 0, the current trace is averaged with the previously stored averaged trace.

Data availability

The applications can only receive data that is available in the capture buffer. As soon as data has been stored to the capture buffer successfully, a status bit (#9) in the `STAT:OPER` register is set. If the required application data is not available, an error message is displayed. Details on restrictions are described in [chapter 6.4, "Restrictions for Applications"](#), on page 29.

6.3 Multi-Standard Analysis

Application data

The applications receive data for analysis from the capture buffer, if necessary resampled or with filters applied. The applications can define their own center frequency, sample rate and record length for their **application data**, which is an **extract of the capture buffer data**. The applications may not request more sample points than the captured data contains, or samples from a frequency outside the range of the capture buffer, for example.

Generally, if a signal contains data channels for multiple standards, the individual applications are used to analyze the channel for the corresponding standard. Thus, it is of interest to know which application, or more precisely: which data channel is analyzing which part of the captured data and how each data channel is correlated (in time) to others.

The MSRA Master display indicates the data covered by each application, restricted to the channel bandwidth used by the corresponding standard, by vertical blue lines labeled with the application name. For applications that support several standards (e.g. VSA, LTE) an estimated or user-defined bandwidth is indicated.

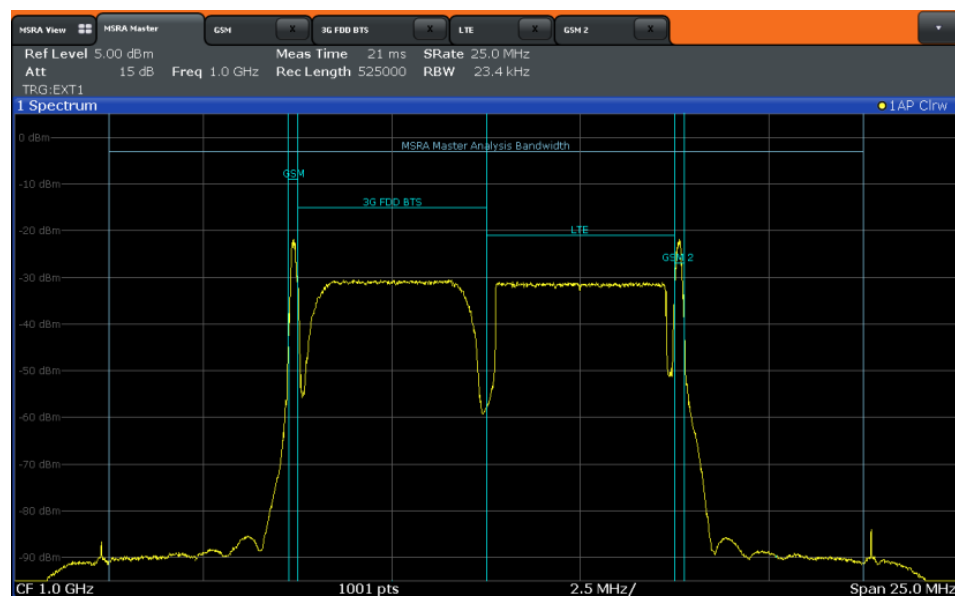

Fig. 6-1: MSRA Master indicating covered bandwidth for 4 applications

Analysis interval

Each application receives an extract of the data from the capture buffer. However, the individual evaluation methods of the application need not analyze the complete data range. Some applications allow you to select a specific part of the data for analysis, e.g. an individual frame, burst or pulse, or to use an offline trigger that defines an additional offset to the capture offset. The data range that is actually analyzed is referred to as the **analysis interval**.

The analysis interval is indicated in the window title bar for each evaluation, and can be queried via remote control.



For applications that do not allow you to restrict the evaluation range (e.g. I/Q Analyzer, Analog Demodulation), the analysis interval is identical to the application data extract.

Trigger offset vs. capture offset

The beginning of the capture buffer is defined by the trigger event and the trigger offset. The trigger source is defined by the MSRA Master, which means that all channels use the same trigger. However, each application might need a different trigger offset or a different number of pretrigger samples. Instead of a trigger offset, the applications define a **capture offset**. The capture offset is defined as an **offset to the beginning of the capture buffer**.

Thus, the beginning of the application data extract is calculated as:

[time of trigger event] + [trigger offset] + [capture offset]

Note that while the trigger offset value may be negative, thus starting before the trigger event, the capture offset may not. A negative capture offset would mean the application data would start before the first sample of the capture buffer. The (pre-)trigger offset in the MSRA Master must be configured such that the required number of pre-trigger samples for the applications are available.

Analysis line

A frequent question when analyzing multi-standard radio signals is how each data channel is correlated (in time) to others. Thus, an analysis line has been introduced. The analysis line is a common time marker for all MSRA applications. It can be positioned in any MSRA application or the MSRA Master and is then adjusted in all other applications. Thus, you can easily analyze the results at a specific time in the measurement in all applications and determine correlations (e.g. cross-talk).

If the marked point in time is contained in the analysis interval of the application, the line is indicated in all time-based result displays, such as time, symbol, slot or bit diagrams. By default, the analysis line is displayed, however, it can be hidden from view manually. In all result displays, the "AL" label in the window title bar indicates whether or not the analysis line lies within the analysis interval or not:

- **orange "AL"**: the line lies within the interval
- **white "AL"**: the line lies within the interval, but is not displayed (hidden)
- **no "AL"**: the line lies outside the interval

6.4 Restrictions for Applications

As mentioned in various contexts before, the MSRA applications themselves are identical to Signal and Spectrum operating mode, however, the correlation between applications and the MSRA Master require some restrictions. Principally, you are not restricted

in setting parameters. However, if any contradictions occur between the configured capture settings and the analysis settings, error messages are displayed in the status bar of the application and an icon (🚫) is displayed next to the channel label. However, it does not matter in which order you configure the settings - you will not be prevented from doing so.

In particular, the following restrictions apply to applications in MSRA mode:

- **Data acquisition:** parameters related to data acquisition can only be configured by the MSRA Master
- **Application data:** only data contained in the capture buffer can be analyzed by the application; this implies the following restrictions:
 - **Center frequency:** must lie within the captured data bandwidth
 - **Measurement time/Record length:** must be smaller than or equal to the values of the MSRA Master
 - **Capture offset:** must be smaller than the record length of the MSRA Master
 - **Trace averaging:** only for sweep count = 0
- **AUTO SET functions:** in applications, only the frequency can be adjusted automatically; all other adjustment functions require a new data acquisition



General restrictions concerning sample rates and maximum usable I/Q bandwidths for I/Q data also apply in MSRA mode; see the R&S FSW I/Q Analyzer User Manual for details.

6.5 Measurements in the Time and Frequency Domain

The I/Q Analyzer application (*not Master*) in **multistandard mode** can also perform measurements on the captured I/Q data in the time and frequency domain. In order to do so, the I/Q Analyzer performs an FFT sweep on the captured I/Q data, providing power vs frequency results, or uses the RBW filter to obtain power vs time (zero span) results. This data is then used for the common frequency or time domain measurements provided by the R&S FSW Spectrum application, such as ACLR, SEM or CCDF.

Configuration

Apart from the data capturing process, the measurements are identical in the Spectrum and I/Q Analyzer applications. They are configured using the same settings and provide the same results. The "Magnitude" result display in the I/Q Analyzer, for instance, will principally show the same results as the zero span measurement for the same data. However, while the "Magnitude" evaluation is configured by the I/Q analysis bandwidth and the measurement time, the zero span measurement is configured by the center frequency, RBW and sweep time settings. Internally, these "time domain" settings are converted to the required I/Q settings by the I/Q Analyzer.

The time and frequency domain measurements and the required settings are described in detail in the R&S FSW User Manual.

Limitations

However, since the data in the I/Q Analyzer application is captured by the Master, independantly of the specific time or frequency measurement requirements concerning the RBW, filter type and number of sweep points in the application, some restrictions may apply to these measurements in the I/Q Analyzer. If not enough samples are available in the captured and converted I/Q data, for example, an error message is displayed in the application.

The **maximum span** for a frequency sweep on I/Q-based data corresponds to the maximum I/Q bandwidth (see [chapter A.3, "Sample Rate and Maximum Usable I/Q Bandwidth for RF Input"](#), on page 150 and [chapter A.4, "Sample Rates and Bandwidths for Digital I/Q Data"](#), on page 157).

The **maximum resolution bandwidth (RBW)** is 1 MHz.

Furthermore, the following **functions** are not available for time and frequency domain measurements in multistandard mode:

- Marker demodulation
- Frequency counter marker
- Gated measurement
- Video trigger

7 Configuration

MSRA is a special operating mode on the R&S FSW, which you activate using the MODE key on the front panel.

When you switch the operating mode of a measurement channel to MSRA mode the first time, the Sequencer is automatically activated in continuous mode (see [chapter 5.3, "Using the Sequencer in MSRA Mode"](#), on page 24), starting an I/Q Analyzer data acquisition with the default settings (but with a "Spectrum" result display). The "I/Q Analyzer" menu is displayed, providing access to the most important configuration functions.

Configuring the MSRA Master

The MSRA Master is the only channel that captures data. It also controls global configuration settings for all applications. Thus, all settings that refer to data acquisition can only be configured in the MSRA Master tab. These settings are deactivated in the configuration overviews and dialog boxes for all application channels. All other settings, e.g. concerning the evaluated data range, the display configuration or analysis, can be configured individually for each application and the Master.



Restrictions

Note that although some restrictions apply to parameters that affect both the MSRA Master and applications (see [chapter 6.4, "Restrictions for Applications"](#), on page 29), it does not matter in which order you configure them. If any contradictions occur between the captured data and the data to be evaluated, error messages are displayed in the status bar of the application and an icon (✖ or !) is displayed next to the channel label. However, you will not be prevented from configuring contradictory settings.



Importing and Exporting I/Q Data

Note that, as opposed to the Signal and Spectrum Analyzer mode, the I/Q data to be evaluated in MSRA mode cannot be imported to the R&S FSW. However, the captured I/Q data from the MSRA Master can be exported for further analysis in external applications.

For details on exporting I/Q data see the R&S FSW I/Q Analyzer User Manual.

Configuring an I/Q Analyzer as an MSRA application

In principle, the I/Q Analyzer in MSRA mode is configured as in Signal and Spectrum Analyzer mode.

However, the I/Q Analyzer application (*not Master*) in MSRA mode can also perform measurements on the captured I/Q data in the time and frequency domain (see also [chapter 6.5, "Measurements in the Time and Frequency Domain"](#), on page 30). Which type of measurement is to be performed - conventional I/Q data analysis or a time or frequency domain measurement - is selected in the "Select Measurement" dialog box, which is now displayed when you do one of the following:

- In the "I/Q Analyzer" menu, select the "Select Meas" softkey.

- Press the MEAS key.

The common measurements as in the Spectrum application are listed. In addition, "IQ Analyzer" is provided under "Basic Measurements" to return to the default I/Q Analysis functions.

The time and frequency domain measurements and the required settings are described in detail in the R&S FSW User Manual. Further configuration of the I/Q Analyzer application is described in the R&S FSW I/Q Analyzer and I/Q Input User Manual.

The following chapters describe configuration for the MSRA Master.

• Default Settings for MSRA Measurements	33
• Configuration Overview	34
• Input Source Settings	35
• Amplitude	43
• Frequency Settings	49
• Trigger Settings	51
• Data Acquisition and Bandwidth Settings	57
• Output Settings	65
• Display Configuration	67
• Automatic Settings	67

7.1 Default Settings for MSRA Measurements

The following default settings are activated directly after the R&S FSW has been set to MSRA mode for the first time, or after presetting the instrument.

Table 7-1: Default settings for MSRA mode

Parameter	Value
Application	I/Q Analyzer (Master)
Sequencer mode	Continuous
Sweep mode	Continuous
Reference level	0 dBm
Attenuation	10 dB
Acquisition time	5 ms
Record length	1001 samples
Sample rate	100.0 MHz
Trigger settings	FREE RUN
Evaluation	Window 1: Spectrum

7.2 Configuration Overview



Throughout the measurement channel configuration, an overview of the most important currently defined settings is provided in the "Overview". The "Overview" is displayed when you select the "Overview" icon, which is available at the bottom of all softkey menus.

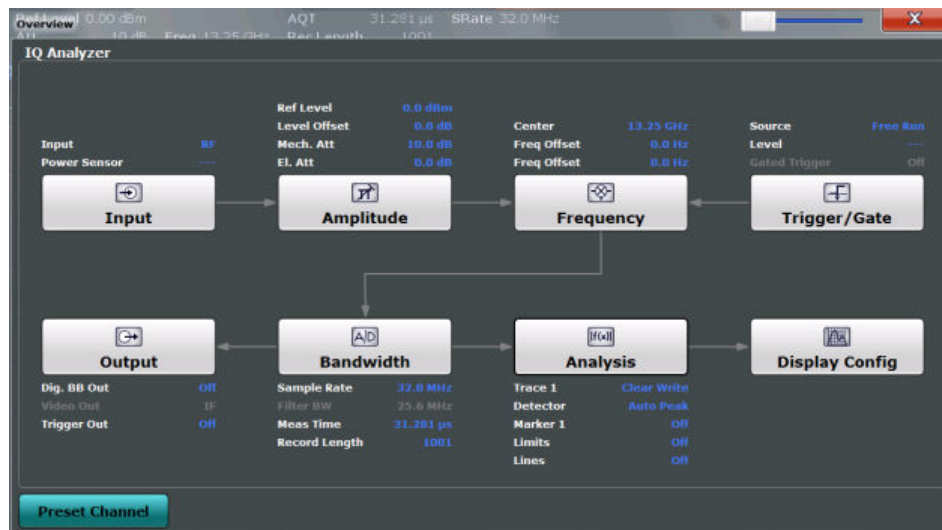

Fig. 7-1: Configuration Overview for MSRA Master

In addition to the main measurement settings, the "Overview" provides quick access to the main settings dialog boxes. The individual configuration steps are displayed in the order of the data flow. Thus, you can easily configure an entire measurement channel from input over processing to output and analysis by stepping through the dialog boxes as indicated in the "Overview".



The "Overview" varies depending on the application; for detailed descriptions see the corresponding application User Manual.

If the I/Q Analyzer is used as an MSRA application, the "Overview" also provides a measurement selection button in order to perform measurements in the frequency and time domain. See the R&S FSW I/Q Analyzer and I/Q Input User Manual for details.

The "Overview" for the MSRA Master provides quick access to the following configuration dialog boxes (listed in the recommended order of processing):

1. Input settings
See [chapter 7.3, "Input Source Settings"](#), on page 35
2. Amplitude settings
See [chapter 7.4, "Amplitude"](#), on page 43
3. Frequency settings
See [chapter 7.5, "Frequency Settings"](#), on page 49
4. Optionally, trigger settings

See [chapter 7.6, "Trigger Settings"](#), on page 51

5. Bandwidth settings
See [chapter 7.7, "Data Acquisition and Bandwidth Settings"](#), on page 57
6. Optionally, output settings
See [chapter 7.8, "Output Settings"](#), on page 65
7. Analysis settings and functions
See [chapter 8, "Analysis"](#), on page 70
8. Display configuration
See [chapter 7.9, "Display Configuration"](#), on page 67

To configure settings

- ▶ Select any button to open the corresponding dialog box.

For step-by-step instructions on configuring MSRA measurements, see [chapter 9, "How to Perform Measurements in MSRA Mode"](#), on page 72.

Preset Channel

Select the "Preset Channel" button in the lower lefthand corner of the "Overview" to restore all measurement settings **in the current channel** to their default values.

Note that the PRESET key on the front panel restores the entire instrument to its default values and thus closes **all measurement channels** on the R&S FSW (except for the default Spectrum application channel)!

For details see [chapter 7.1, "Default Settings for MSRA Measurements"](#), on page 33.

Remote command:

`SYSTem:PRESet:CHANnel[:EXECute]` on page 93

Specifics for

The measurement channel may contain several windows for different results. Thus, the settings indicated in the "Overview" and configured in the dialog boxes vary depending on the selected window.

Select an active window from the "Specifics for" selection list that is displayed in the "Overview" and in all window-specific configuration dialog boxes.

The "Overview" and dialog boxes are updated to indicate the settings for the selected window.

7.3 Input Source Settings

The input source determines which data the R&S FSW will analyze.

Input settings can be configured in the "Input" dialog box.

Some settings are also available in the "Amplitude" tab of the "Amplitude" dialog box.

Since the Digital I/Q input and the Analog Baseband input use the same digital signal path, both cannot be used simultaneously. When one is activated, established connections for the other are disconnected. When the second input is deactivated, connections to the first are re-established. This may cause a short delay in data transfer after switching the input source.

External mixers are not supported in MSRA/MSRT mode.

- [Radio Frequency Input](#).....36
- [Digital I/Q Input Settings](#)..... 38
- [Analog Baseband Input Settings](#).....40
- [Probe Settings](#).....42

7.3.1 Radio Frequency Input

The default input source for the R&S FSW is "Radio Frequency", i.e. the signal at the RF INPUT connector on the front panel of the R&S FSW. If no additional options are installed, this is the only available input source.



- [Input Coupling](#)..... 36
- [Impedance](#)..... 37
- [High-Pass Filter 1...3 GHz](#)..... 37
- [YIG-Preselector](#).....37
- [Input Connector](#).....37

Input Coupling

The RF input of the R&S FSW can be coupled by alternating current (AC) or direct current (DC).

AC coupling blocks any DC voltage from the input signal. This is the default setting to prevent damage to the instrument. Very low frequencies in the input signal may be distorted.

However, some specifications require DC coupling. In this case, you must protect the instrument from damaging DC input voltages manually. For details, refer to the data sheet.

Remote command:

`INPut:COUPling` on page 95

Impedance

The reference impedance for the measured levels of the R&S FSW can be set to 50 Ω or 75 Ω .

75 Ω should be selected if the 50 Ω input impedance is transformed to a higher impedance using a 75 Ω adapter of the RAZ type (= 25 Ω in series to the input impedance of the instrument). The correction value in this case is 1.76 dB = 10 log (75 Ω /50 Ω).

This value also affects the unit conversion (see "Reference Level" on page 44).

Remote command:

`INPut:IMPedance` on page 96

High-Pass Filter 1...3 GHz

Activates an additional internal high-pass filter for RF input signals from 1 GHz to 3 GHz. This filter is used to remove the harmonics of the R&S FSW in order to measure the harmonics for a DUT, for example.

This function requires option R&S FSW-B13.

(Note: for RF input signals outside the specified range, the high-pass filter has no effect. For signals with a frequency of approximately 4 GHz upwards, the harmonics are suppressed sufficiently by the YIG filter.)

Remote command:

`INPut:FILTer:HPASs[:STATe]` on page 95

YIG-Preselector

Activates or deactivates the YIG-preselector.

An internal YIG-preselector at the input of the R&S FSW ensures that image frequencies are rejected. However, this is only possible for a restricted bandwidth. In order to use the maximum bandwidth for signal analysis you can deactivate the YIG-preselector at the input of the R&S FSW, which may lead to image-frequency display.

Note that the YIG-preselector is active only on frequencies greater than 8 GHz. Therefore, switching the YIG-preselector on or off has no effect if the frequency is below that value.

Note:

For the following measurements, the YIG-Preselector is off by default (if available).

- I/Q Analyzer (and thus in all applications in MSRA operating mode)
- Multi-Carrier Group Delay
- GSM
- VSA

Remote command:

`INPut:FILTer:YIG[:STATe]` on page 96

Input Connector

Determines whether the RF input data is taken from the RF INPUT connector (default) or the optional BASEBAND INPUT I connector. This setting is only available if the Analog Baseband Interface (R&S FSW-B71) is installed and active for input. It is not available for the R&S FSW67.

For more information on the Analog Baseband Interface (R&S FSW-B71) see the R&S FSW I/Q Analyzer and I/Q Input User Manual.

Remote command:

[INPut:CONNector](#) on page 94

7.3.2 Digital I/Q Input Settings

The following settings and functions are available to provide input via the Digital Baseband Interface (R&S FSW-B17) in the applications that support it.

They can be configured via the INPUT/OUTPUT key, in the "Input" dialog box.

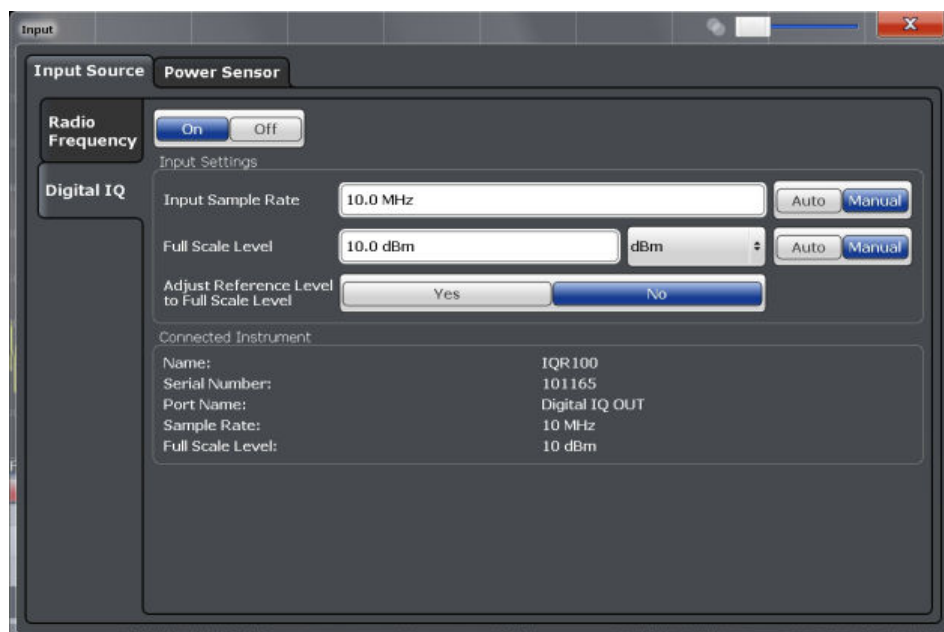

For more information see the R&S FSW I/Q Analyzer and I/Q Input User Manual.

Digital I/Q Input State	38
Input Sample Rate	38
Full Scale Level	39
Adjust Reference Level to Full Scale Level	39
Connected Instrument	39
DigIConf	39

Digital I/Q Input State

Enables or disable the use of the "Digital IQ" input source for measurements. "Digital IQ" is only available if the Digital Baseband Interface (R&S FSW-B17) is installed.

Remote command:

[INPut:SELEct](#) on page 96

Input Sample Rate

Defines the sample rate of the digital I/Q signal source. This sample rate must correspond with the sample rate provided by the connected device, e.g. a generator.

If "Auto" is selected, the sample rate is adjusted automatically by the connected device.

The allowed range is from 100 Hz to 10 GHz.

Remote command:

`INPut:DIQ:SRATe` on page 100

`INPut:DIQ:SRATe:AUTO` on page 100

Full Scale Level

The "Full Scale Level" defines the level and unit that should correspond to an I/Q sample with the magnitude "1".

If "Auto" is selected, the level is automatically set to the value provided by the connected device.

Remote command:

`INPut:DIQ:RANGe[:UPPer]` on page 99

`INPut:DIQ:RANGe[:UPPer]:UNIT` on page 99

`INPut:DIQ:RANGe[:UPPer]:AUTO` on page 98

Adjust Reference Level to Full Scale Level

If enabled, the reference level is adjusted to the full scale level automatically if any change occurs.

Remote command:

`INPut:DIQ:RANGe:COUPling` on page 99

Connected Instrument

Displays the status of the Digital Baseband Interface connection.

If an instrument is connected, the following information is displayed:

- Name and serial number of the instrument connected to the Digital Baseband Interface
- Used port
- Sample rate of the data currently being transferred via the Digital Baseband Interface
- Level and unit that corresponds to an I/Q sample with the magnitude "1" ([Full Scale Level](#)), if provided by connected instrument

Remote command:

`INPut:DIQ:CDEvice` on page 97

DigIConf

Starts the optional R&S DigIConf application. This softkey is available in the In-/Output menu, but only if the optional software is installed.

Note that R&S DigIConf requires a USB connection (not LAN!) from the R&S FSW to the R&S EX-IQ-BOX in addition to the Digital Baseband Interface (R&S FSW-B17) connection. R&S DigIConf version 2.20.360.86 Build 170 or higher is required.

To return to the R&S FSW application, press any key on the front panel. The R&S FSW application is displayed with the "Input/Output" menu, regardless of which key was pressed.

For details on the R&S DigIConf application, see the "R&S®EX-IQ-BOX Digital Interface Module R&S®DigIConf Software Operating Manual".

Note: If you close the R&S DigIConf window using the "Close" icon, the window is minimized, not closed.

If you select the "File > Exit" menu item in the R&S DigIConf window, the application is closed. Note that in this case the settings are lost and the EX-IQ-BOX functionality is no longer available until you restart the application using the "DigIConf" softkey in the R&S FSW once again.

7.3.3 Analog Baseband Input Settings

The following settings and functions are available to provide input via the Analog Baseband Interface (R&S FSW-B71) in the applications that support it.

They can be configured via the INPUT/OUTPUT key, in the "Input" dialog box.

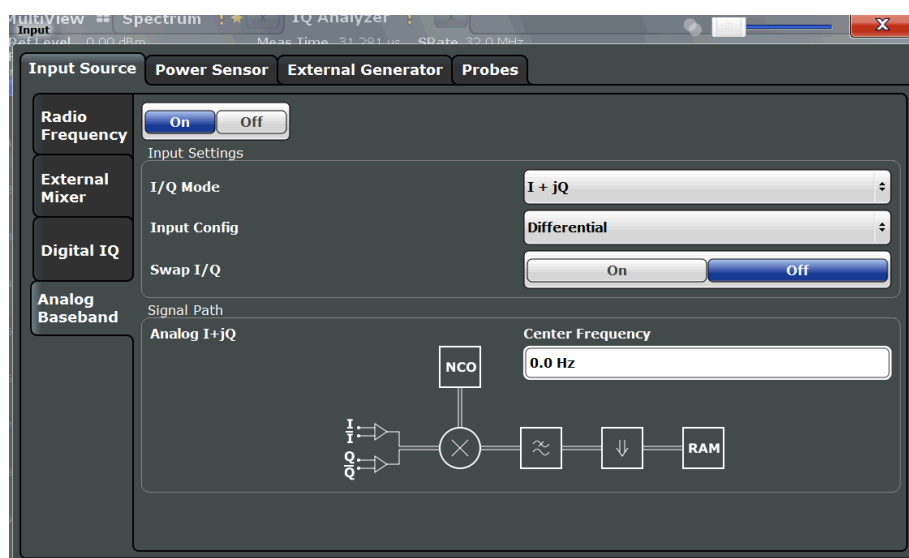

For more information on the Analog Baseband Interface (R&S FSW-B71) see the R&S FSW I/Q Analyzer and I/Q Input User Manual.

Analog Baseband Input State	40
I/Q Mode	41
Input configuration	41
Center Frequency	41

Analog Baseband Input State

Enables or disable the use of the "Analog Baseband" input source for measurements. "Analog Baseband" is only available if the Analog Baseband Interface (R&S FSW-B71) is installed.

Remote command:

[INPut : SELEct](#) on page 96

I/Q Mode

Defines the format of the input signal.

For more information on I/Q data processing modes see the R&S FSW I/Q Analyzer and I/Q Input User Manual.

"I + jQ" The input signal is filtered and resampled to the sample rate of the application.
Two inputs are required for a complex signal, one for the in-phase component, and one for the quadrature component.

"I Only / Low IF I"

The input signal at the BASEBAND INPUT I connector is filtered and resampled to the sample rate of the application.
If the center frequency is set to 0 Hz, the real baseband signal is displayed without down-conversion (**Real Baseband I**).
If a center frequency greater than 0 Hz is set, the input signal is down-converted with the center frequency (**Low IF I**).

"Q Only / Low IF Q"

The input signal at the BASEBAND INPUT Q connector is filtered and resampled to the sample rate of the application.
If the center frequency is set to 0 Hz, the real baseband signal is displayed without down-conversion (**Real Baseband Q**).
If a center frequency greater than 0 Hz is set, the input signal is down-converted with the center frequency (**Low IF Q**).

Remote command:

[INPut: IQ:TYPE](#) on page 102

Input configuration

Defines whether the input is provided as a differential signal via all 4 Analog Baseband connectors or as a plain I/Q signal via 2 simple-ended lines.

Note: Both single-ended and differential probes are supported as input; however, since only one connector is occupied by a probe, the "Single-ended" setting must be used for all probes.

"Differential" I, Q and inverse I,Q data

"Single Ended" I, Q data only

Remote command:

[INPut: IQ:BALanced\[:STATE\]](#) on page 101

Center Frequency

Defines the center frequency for analog baseband input.

For real-type baseband input (I or Q only), the center frequency is always 0 Hz.

Note: If the analysis bandwidth to either side of the defined center frequency exceeds the minimum frequency (0 Hz) or the maximum frequency (40 MHz/80 MHz), an error is displayed. In this case, adjust the center frequency or the analysis bandwidth.

For details on frequency ranges and the analysis bandwidth see the R&S FSW I/Q Analyzer and I/Q Input User Manual.

Remote command:

[SENSe:] FREQuency:CENTer on page 112

7.3.4 Probe Settings

Probes are configured in a separate tab on the "Input" dialog box which is displayed when you select the INPUT/OUTPUT key and then "Input Source Config".

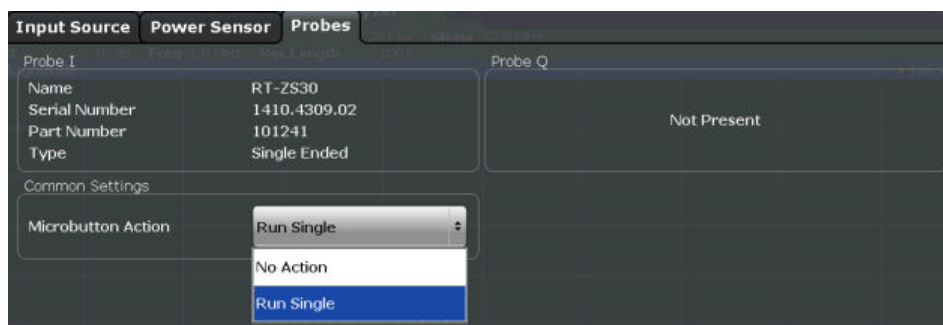

For each possible probe connector (Baseband Input I, Baseband Input Q), the detected type of probe, if any, is displayed. The following information is provided for each connected probe:

- Probe name
- Serial number
- R&S part number
- Type of probe ("Differential", "Single Ended")

For more information on using probes with an R&S FSW, see the R&S FSW User Manual.

For general information on the R&S®RTO probes, see the device manuals.

[Microbutton Action](#)..... 42

Microbutton Action

Active R&S probes (except for RT-ZS10E) have a configurable microbutton on the probe head. By pressing this button, you can perform an action on the instrument directly from the probe.

Select the action that you want to start from the probe:

- "Run single" Starts one data acquisition.
- "No action" Prevents unwanted actions due to unintended usage of the microbutton.

Remote command:

[SENSe:] PROBe<p>: SETup:MODE on page 105

7.4 Amplitude

The amplitude is configured in the "Amplitude" dialog box. Amplitude settings are identical to the Signal and Spectrum Analyzer mode.

For background information on amplitude settings see the R&S FSW User Manual.

7.4.1 Amplitude Settings

Amplitude settings determine how the R&S FSW must process or display the expected input power levels.

Amplitude settings for input from the Analog Baseband interface (R&S FSW-B71) are described in [chapter 7.4.2, "Amplitude Settings for Analog Baseband Input"](#), on page 46.

To configure the amplitude settings

Amplitude settings can be configured via the AMPT key or in the "Amplitude" dialog box.

- ▶ To display the "Amplitude" dialog box, do one of the following:
 - Select "Input/Frontend" from the "Overview" and then switch to the "Amplitude" tab.
 - Select the AMPT key and then the "Amplitude Config" softkey.

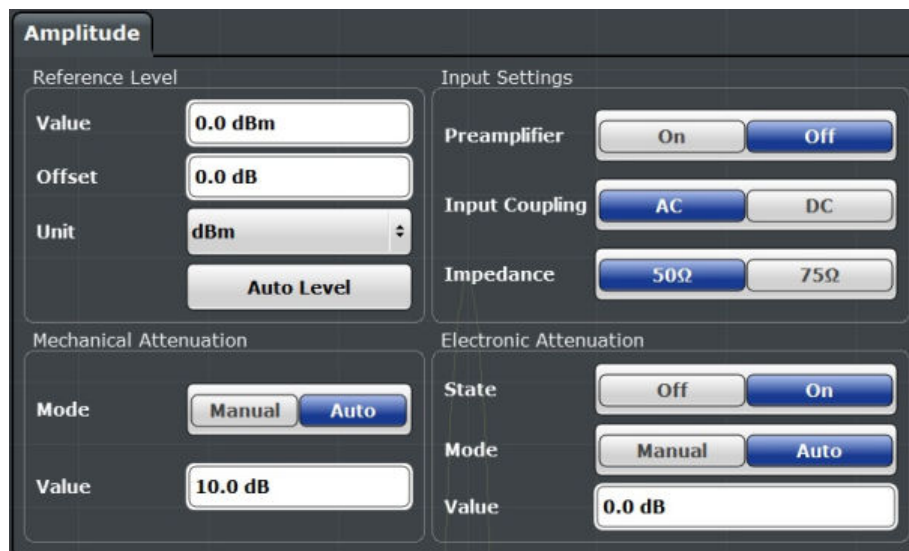

Reference Level.....	44
└ Shifting the Display (Offset).....	44
RF Attenuation.....	44
└ Attenuation Mode / Value.....	44
Using Electronic Attenuation (Option B25).....	45
Input Settings.....	45
└ Preamplifier (option B24).....	45

Reference Level

Defines the expected maximum reference level. Signal levels above this value may not be measured correctly, which is indicated by the "IF OVLD" status display ("OVLD" for analog baseband or digital baseband input).

The reference level is also used to scale power diagrams; the reference level is then used as the maximum on the y-axis.

Since the R&S FSW hardware is adapted according to this value, it is recommended that you set the reference level close above the expected maximum signal level to ensure an optimum measurement (no compression, good signal-to-noise ratio).

Note that the "Reference Level" value ignores the [Shifting the Display \(Offset\)](#). It is important to know the actual power level the R&S FSW must handle.

Note that for input from the External Mixer (R&S FSW-B21) the maximum reference level also depends on the conversion loss; see the R&S FSW I/Q Analyzer and I/Q Input User Manual for details.

Remote command:

`DISPlay[:WINDow<n>]:TRACe:Y[:SCALe]:RLEVel` on page 107

Shifting the Display (Offset) ← Reference Level

Defines an arithmetic level offset. This offset is added to the measured level irrespective of the selected unit. The scaling of the y-axis is changed accordingly.

Define an offset if the signal is attenuated or amplified before it is fed into the R&S FSW so the application shows correct power results. All displayed power level results will be shifted by this value.

Note, however, that the [Reference Level](#) value ignores the "Reference Level Offset". It is important to know the actual power level the R&S FSW must handle.

To determine the required offset, consider the external attenuation or gain applied to the input signal. A positive value indicates that an attenuation took place (R&S FSW increases the displayed power values), a negative value indicates an external gain (R&S FSW decreases the displayed power values).

The setting range is ± 200 dB in 0.01 dB steps.

Remote command:

`DISPlay[:WINDow<n>]:TRACe:Y[:SCALe]:RLEVel:OFFSet` on page 108

RF Attenuation

Defines the attenuation applied to the RF input.

Attenuation Mode / Value ← RF Attenuation

The RF attenuation can be set automatically as a function of the selected reference level (Auto mode). This ensures that the optimum RF attenuation is always used. It is the default setting. By default and when [Using Electronic Attenuation \(Option B25\)](#) is not available, mechanical attenuation is applied.

In "Manual" mode, you can set the RF attenuation in 1 dB steps (down to 0 dB, also using the rotary knob). Other entries are rounded to the next integer value. The range is specified in the data sheet. If the defined reference level cannot be set for the defined RF attenuation, the reference level is adjusted accordingly and the warning "Limit reached" is displayed.

NOTICE! Risk of hardware damage due to high power levels. When decreasing the attenuation manually, ensure that the power level does not exceed the maximum level allowed at the RF input, as an overload may lead to hardware damage.

Remote command:

`INPut:ATTenuation` on page 108

`INPut:ATTenuation:AUTO` on page 108

Using Electronic Attenuation (Option B25)

If option R&S FSW-B25 is installed, you can also activate an electronic attenuator.

In "Auto" mode, the settings are defined automatically; in "Manual" mode, you can define the mechanical and electronic attenuation separately.

Note: Electronic attenuation is not available for stop frequencies (or center frequencies in zero span) >13.6 GHz.

In "Auto" mode, RF attenuation is provided by the electronic attenuator as much as possible to reduce the amount of mechanical switching required. Mechanical attenuation may provide a better signal-to-noise ratio, however.

When you switch off electronic attenuation, the RF attenuation is automatically set to the same mode (auto/manual) as the electronic attenuation was set to. Thus, the RF attenuation may be set to automatic mode, and the full attenuation is provided by the mechanical attenuator, if possible.

Both the electronic and the mechanical attenuation can be varied in 1 dB steps. Other entries are rounded to the next lower integer value.

If the defined reference level cannot be set for the given attenuation, the reference level is adjusted accordingly and the warning "Limit reached" is displayed in the status bar.

Remote command:

`INPut:EATT:STATe` on page 109

`INPut:EATT:AUTO` on page 109

`INPut:EATT` on page 109

Input Settings

Some input settings affect the measured amplitude of the signal, as well.

The parameters "Input Coupling" and "Impedance" are identical to those in the "Input" settings, see [chapter 7.3, "Input Source Settings"](#), on page 35.

Preamplifier (option B24) ← Input Settings

If option R&S FSW-B24 is installed, a preamplifier can be activated for the RF input signal.

You can use a preamplifier to analyze signals from DUTs with low input power.

For R&S FSW 26 or higher models, the input signal is amplified by 30 dB if the preamplifier is activated.

For R&S FSW 8 or 13 models, the following settings are available:

"Off" Deactivates the preamplifier.

"15 dB" The RF input signal is amplified by about 15 dB.

"30 dB" The RF input signal is amplified by about 30 dB.

Remote command:

`INPut:GAIN:STATe` on page 110

`INPut:GAIN[:VALue]` on page 110

7.4.2 Amplitude Settings for Analog Baseband Input

The following settings and functions are available to define amplitude settings for input via the Analog Baseband Interface (R&S FSW-B71) in the applications that support it.

They can be configured via the AMPT key or in the "Amplitude" tab of the "Input" dialog box.

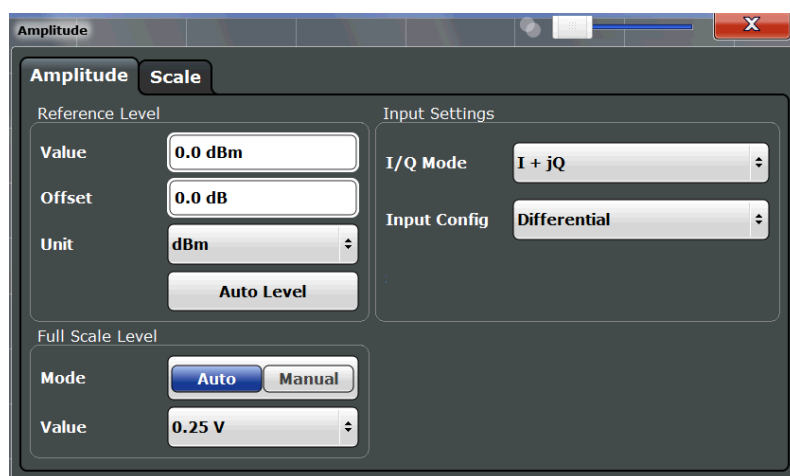

The input settings provided here are identical to those in the "Input Source" > "Analog Baseband" tab, see [chapter 7.3.3, "Analog Baseband Input Settings"](#), on page 40.

For more information on the Analog Baseband Interface (R&S FSW-B71) see the R&S FSW I/Q Analyzer and I/Q Input User Manual.

[Reference Level](#).....46
 ↳ [Shifting the Display \(Offset\)](#).....47
[Full Scale Level Mode / Value](#).....47

Reference Level

Defines the expected maximum reference level. Signal levels above this value may not be measured correctly, which is indicated by the "IF OVLD" status display ("OVLD" for analog baseband or digital baseband input).

The reference level is also used to scale power diagrams; the reference level is then used as the maximum on the y-axis.

Since the R&S FSW hardware is adapted according to this value, it is recommended that you set the reference level close above the expected maximum signal level to ensure an optimum measurement (no compression, good signal-to-noise ratio).

Note that the "Reference Level" value ignores the [Shifting the Display \(Offset\)](#). It is important to know the actual power level the R&S FSW must handle.

Note that for input from the External Mixer (R&S FSW-B21) the maximum reference level also depends on the conversion loss; see the R&S FSW I/Q Analyzer and I/Q Input User Manual for details.

Remote command:

`DISPlay[:WINDow<n>]:TRACe:Y[:SCALe]:RLEVel` on page 107

Shifting the Display (Offset) ← Reference Level

Defines an arithmetic level offset. This offset is added to the measured level irrespective of the selected unit. The scaling of the y-axis is changed accordingly.

Define an offset if the signal is attenuated or amplified before it is fed into the R&S FSW so the application shows correct power results. All displayed power level results will be shifted by this value.

Note, however, that the [Reference Level](#) value ignores the "Reference Level Offset". It is important to know the actual power level the R&S FSW must handle.

To determine the required offset, consider the external attenuation or gain applied to the input signal. A positive value indicates that an attenuation took place (R&S FSW increases the displayed power values), a negative value indicates an external gain (R&S FSW decreases the displayed power values).

The setting range is ± 200 dB in 0.01 dB steps.

Remote command:

`DISPlay[:WINDow<n>]:TRACe:Y[:SCALe]:RLEVel:OFFSet` on page 108

Full Scale Level Mode / Value

The full scale level defines the maximum power you can input at the Baseband Input connector without clipping the signal.

The full scale level can be defined automatically according to the reference level, or manually.

For manual input, the following values can be selected:

- 0.25 V
- 0.5 V
- 1 V
- 2 V

If probes are connected, the possible full scale values are adapted according to the probe's attenuation and maximum allowed power.

For details on probes see the R&S FSW I/Q Analyzer and I/Q Input User Manual.

Remote command:

`INPut:IQ:FULLScale:AUTO` on page 101

`INPut:IQ:FULLScale[:LEVel]` on page 101

7.4.3 Scaling the Y-Axis

The individual scaling settings that affect the vertical axis are described here.

To configure the y-axis scaling settings

Vertical Axis settings can be configured via the AMPT key or in the "Amplitude" dialog box.

- ▶ To display the "Amplitude" dialog box, do one of the following:
 - Select "Amplitude" from the "Overview".
 - Select the AMPT key and then the "Scale Config" softkey.

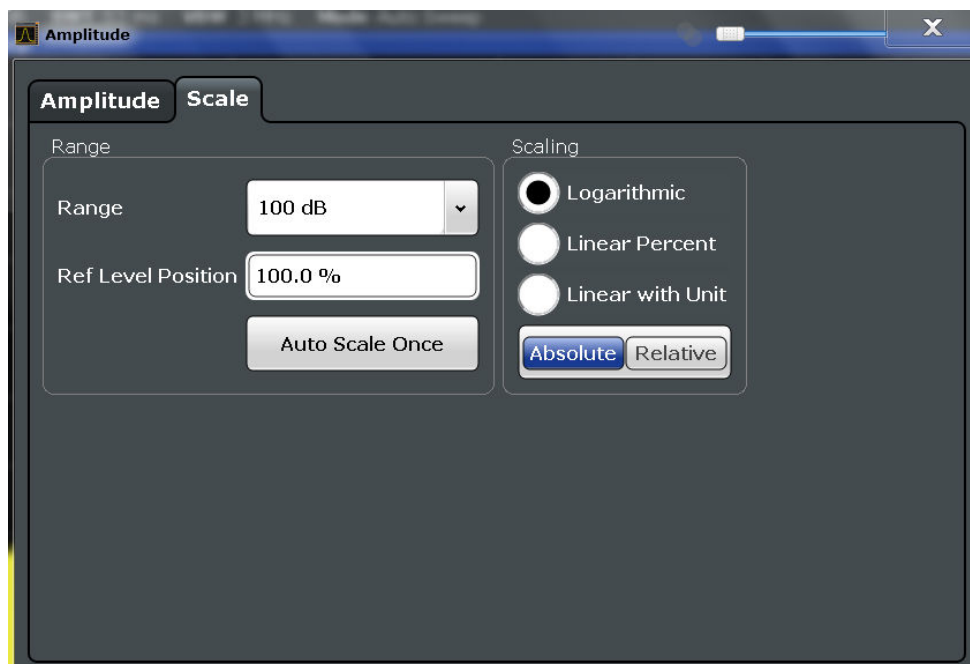

Range.....48
 Ref Level Position.....48
 Scaling.....48
 Y-Axis Max.....49

Range

Defines the displayed y-axis range in dB.

The default value is 100 dB.

Remote command:

`DISPlay[:WINDow<n>]:TRACe:Y[:SCALE]` on page 110

Ref Level Position

Defines the reference level position, i.e. the position of the maximum AD converter value on the level axis in %, where 0 % corresponds to the lower and 100 % to the upper limit of the diagram.

Remote command:

`DISPlay[:WINDow<n>]:TRACe:Y[:SCALE]:RPOSITION` on page 111

Scaling

Defines the scaling method for the y-axis.

"Logarithmic"	Logarithmic scaling (only available for logarithmic units - dB..., and A, V, Watt)
"Linear Unit"	Linear scaling in the unit of the measured signal
"Linear Percent"	Linear scaling in percentages from 0 to 100
"Absolute"	The labeling of the level lines refers to the absolute value of the reference level (not available for "Linear Percent")
"Relative"	The scaling is in dB, relative to the reference level (only available for logarithmic units - dB...). The upper line of the grid (reference level) is always at 0 dB.

Remote command:

[DISPlay\[:WINDow<n>\]:TRACe:Y:SPACing](#) on page 111

[DISPlay\[:WINDow<n>\]:TRACe:Y\[:SCALe\]:MODE](#) on page 111

Y-Axis Max

Defines the maximum value of the y-axis in the currently selected diagram in either direction (in Volts). Thus, the y-axis scale starts at <Y-Axis Max> and ends at +<Y-Axis Max>.

The maximum y-axis value depends on the current reference level. If the reference level is changed, the "Y-Axis Max" value is automatically set to the new reference level (in V).

This command is only available if the evaluation mode for the I/Q Analyzer is set to "IQ Vector" or "Real/Imag".

Remote command:

[DISPlay\[:WINDow<n>\]:TRACe:Y\[:SCALe\]](#) on page 110

7.5 Frequency Settings

Frequency settings for the input signal can be configured via the "Frequency" dialog box, which is displayed when you do one of the following:

- Select the **FREQ** key and then the "Frequency Config" softkey.
- Select "Frequency" from the "Overview".

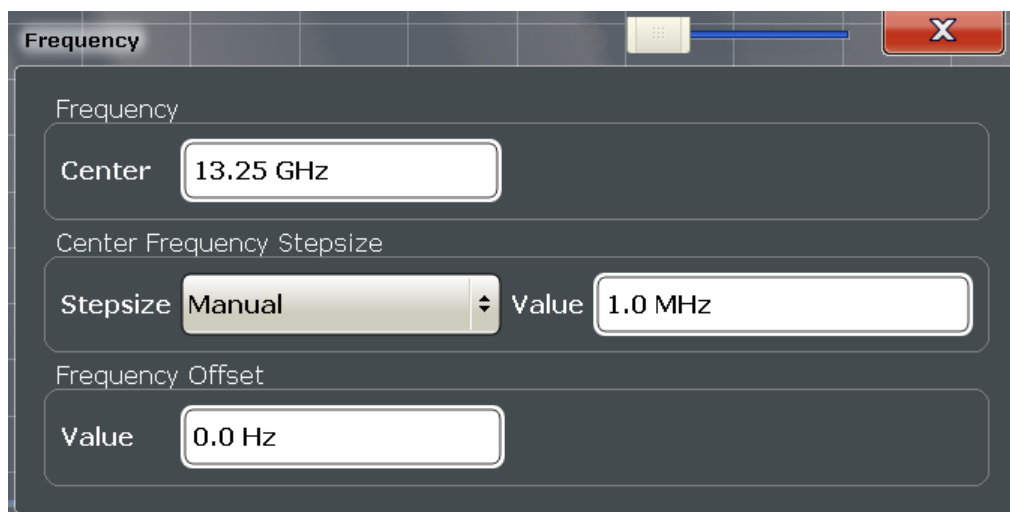

Center frequency.....50
 Center Frequency Stepsize.....50
 Frequency Offset.....50

Center frequency

Defines the normal center frequency of the signal. The allowed range of values for the center frequency depends on the frequency span.

f_{max} and $span_{min}$ are specified in the data sheet.

Remote command:

[SENSe:] FREQuency:CENTer on page 112

Center Frequency Stepsize

Defines the step size by which the center frequency is increased or decreased when the arrow keys are pressed. When you use the rotary knob the center frequency changes in steps of only 1/10 of the "Center Frequency Stepsize".

The step size can be coupled to another value or it can be manually set to a fixed value.

"= Center" Sets the step size to the value of the center frequency. The used value is indicated in the "Value" field.

"Manual" Defines a fixed step size for the center frequency. Enter the step size in the "Value" field.

Remote command:

[SENSe:] FREQuency:CENTer:STEP on page 113

Frequency Offset

Shifts the displayed frequency range along the x-axis by the defined offset.

This parameter has no effect on the R&S FSW hardware, or on the captured data or on data processing. It is simply a manipulation of the final results in which absolute frequency values are displayed. Thus, the x-axis of a spectrum display is shifted by a constant offset if it shows absolute frequencies, but not if it shows frequencies relative to the signal's center frequency.

A frequency offset can be used to correct the display of a signal that is slightly distorted by the measurement setup, for example.

The allowed values range from -100 GHz to 100 GHz. The default setting is 0 Hz.

Remote command:

[SENSe:] FREQuency: OFFSet on page 113

7.6 Trigger Settings

Trigger settings determine when the input signal is measured. These settings are only available for the MSRA Master.



The "Capture Offset", which has a similar function to the trigger offset but is available for MSRA applications only, is described in [chapter 7.7, "Data Acquisition and Bandwidth Settings"](#), on page 57.

Trigger settings can be configured via the TRIG key or in the "Trigger" dialog box, which is displayed when you select the "Trigger" button in the "Overview".

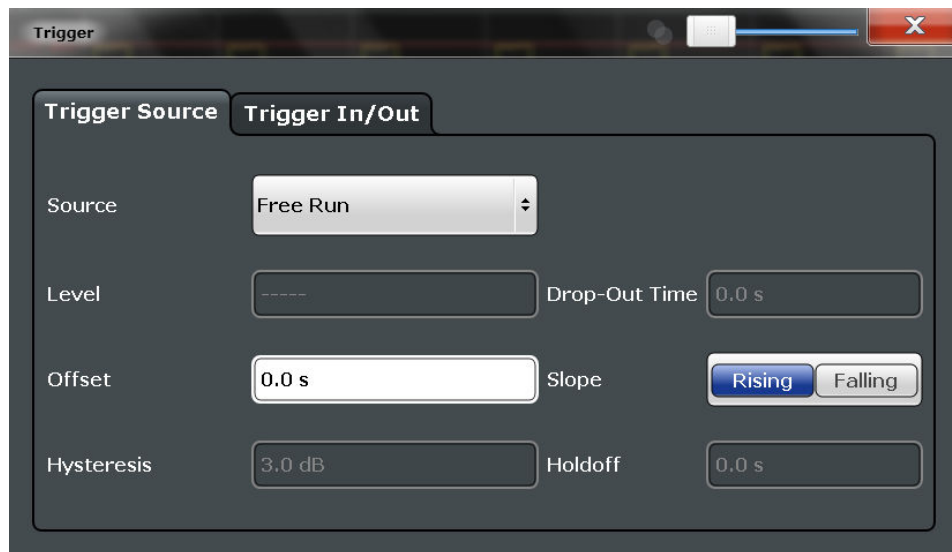

External triggers from one of the TRIGGER INPUT/OUTPUT connectors on the R&S FSW are configured in a separate tab of the dialog box.

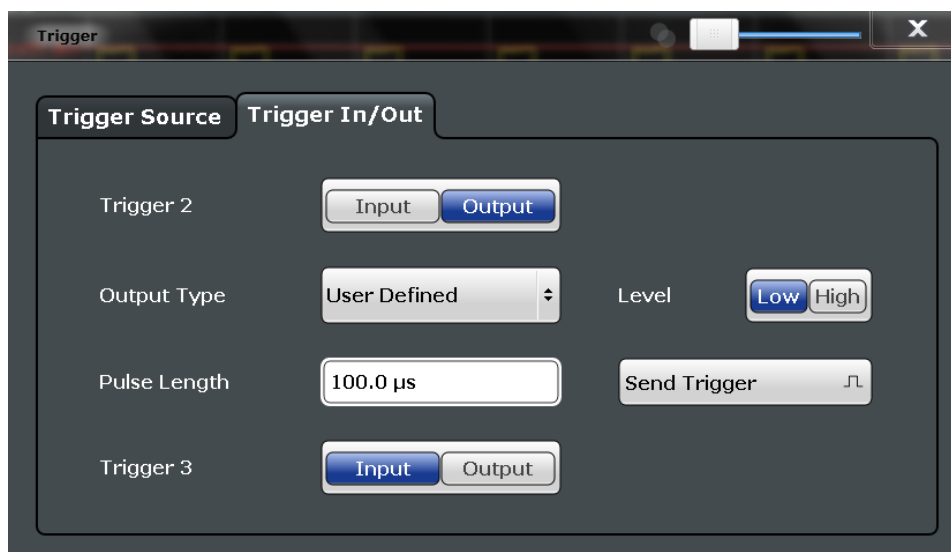

For step-by-step instructions on configuring triggered measurements, see the R&S FSW User Manual.

- Trigger Source..... 52
 - L Trigger Source..... 52
 - L Free Run..... 53
 - L External Trigger 1/2/3..... 53
 - L Baseband Power..... 53
 - L Digital I/Q..... 53
 - L RF Power..... 54
 - L I/Q Power..... 54
 - L Power Sensor..... 54
 - L Trigger Level..... 55
 - L Repetition Interval..... 55
 - L Drop-Out Time..... 55
 - L Trigger Offset..... 55
 - L Hysteresis..... 56
 - L Trigger Holdoff..... 56
 - L Slope..... 56
- Trigger 2/3..... 56
 - L Output Type..... 56
 - L Level..... 57
 - L Pulse Length..... 57
 - L Send Trigger..... 57

Trigger Source

The trigger settings define the beginning of a measurement.

Trigger Source ← Trigger Source

Defines the trigger source. If a trigger source other than "Free Run" is set, "TRG" is displayed in the channel bar and the trigger source is indicated.

Remote command:

TRIGger [: SEquence] : SOURce on page 118

Free Run ← Trigger Source ← Trigger Source

No trigger source is considered. Data acquisition is started manually or automatically and continues until stopped explicitly.

Remote command:

TRIG:SOUR IMM, see [TRIGger\[:SEquence\]:SOURce](#) on page 118

External Trigger 1/2/3 ← Trigger Source ← Trigger Source

Data acquisition starts when the TTL signal fed into the specified input connector (on the front or rear panel) meets or exceeds the specified trigger level.

(See "[Trigger Level](#)" on page 55).

Note: The "External Trigger 1" softkey automatically selects the trigger signal from the TRIGGER INPUT connector on the front panel.

For details see the "Instrument Tour" chapter in the R&S FSW Getting Started manual.

"External Trigger 1"

Trigger signal from the TRIGGER INPUT connector on the front panel.

"External Trigger 2"

Trigger signal from the TRIGGER INPUT/OUTPUT connector on the front panel.

"External Trigger 3"

Trigger signal from the TRIGGER 3 INPUT/ OUTPUT connector on the rear panel.

Remote command:

TRIG:SOUR EXT, TRIG:SOUR EXT2
TRIG:SOUR EXT3

See [TRIGger\[:SEquence\]:SOURce](#) on page 118

Baseband Power ← Trigger Source ← Trigger Source

Defines triggering on the baseband power (for baseband input via the Digital Baseband Interface R&S FSW-B17 or the Analog Baseband interface R&S FSW-B71)).

For more information on the the Digital Baseband Interface or the Analog Baseband Interface see the R&S FSW I/Q Analyzer and I/Q Input User Manual.

Remote command:

TRIG:SOUR BBP, see [TRIGger\[:SEquence\]:SOURce](#) on page 118

Digital I/Q ← Trigger Source ← Trigger Source

For applications that process I/Q data, such as the I/Q Analyzer or optional applications, and only if the Digital Baseband Interface (R&S FSW-B17) is available:

Defines triggering of the measurement directly via the LVDS connector. In the selection list you must specify which general purpose bit (GP0 to GP5) will provide the trigger data.

Note:

If the Digital I/Q enhanced mode is used, i.e. the connected device supports transfer rates up to 200 Msps, only the general purpose bits GP0 and GP1 are available as a Digital I/Q trigger source.

The following table describes the assignment of the general purpose bits to the LVDS connector pins.

Table 7-2: Assignment of general purpose bits to LVDS connector pins

Bit	LVDS pin
GP0	SDATA4_P - Trigger1
GP1	SDATA4_P - Trigger2
GP2 *)	SDATA0_P - Reserve1
GP3 *)	SDATA4_P - Reserve2
GP4 *)	SDATA0_P - Marker1
GP5 *)	SDATA4_P - Marker2
*): not available for Digital I/Q enhanced mode	

Remote command:

TRIG:SOUR GP0, see [TRIGger\[:SEquence\]:SOURce](#) on page 118

RF Power ← Trigger Source ← Trigger Source

Defines triggering of the measurement via signals which are outside the displayed measurement range.

For this purpose the instrument uses a level detector at the first intermediate frequency. The input signal must be in the frequency range between 500 MHz and 8 GHz.

The resulting trigger level at the RF input depends on the RF attenuation and preamplification. For details on available trigger levels see the data sheet.

Note: If the input signal contains frequencies outside of this range (e.g. for fullspan measurements), the sweep may be aborted and a message indicating the allowed input frequencies is displayed in the status bar.

A "Trigger Offset", "Trigger Polarity" and "Trigger Holdoff" (to improve the trigger stability) can be defined for the RF trigger, but no "Hysteresis".

Remote command:

TRIG:SOUR RFP, see [TRIGger\[:SEquence\]:SOURce](#) on page 118

I/Q Power ← Trigger Source ← Trigger Source

This trigger source is not available if the optional Digital Baseband Interface (R&S FSW-B17) or Analog Baseband Interface (R&S FSW-B71) is used for input. It is also not available for analysis bandwidths ≥ 160 MHz.

Triggers the measurement when the magnitude of the sampled I/Q data exceeds the trigger threshold.

Remote command:

TRIG:SOUR IQP, see [TRIGger\[:SEquence\]:SOURce](#) on page 118

Power Sensor ← Trigger Source ← Trigger Source

Uses an external power sensor as a trigger source. This option is only available if a power sensor is connected and configured.

Note: For R&S power sensors, the "Gate Mode" *Lvl* is not supported. The signal sent by these sensors merely reflects the instant the level is first exceeded, rather than a time period. However, only time periods can be used for gating in level mode. Thus, the trigger impulse from the sensors is not long enough for a fully gated measurement; the measurement cannot be completed.

Remote command:

TRIG:SOUR PSE, see TRIGger[:SEquence]:SOURce on page 118

Trigger Level ← Trigger Source

Defines the trigger level for the specified trigger source.

For details on supported trigger levels, see the data sheet.

Remote command:

TRIGger[:SEquence]:LEVel[:EXternal<port>] on page 117

Repetition Interval ← Trigger Source

Defines the repetition interval for a time trigger. The shortest interval is 2 ms.

The repetition interval should be set to the exact pulse period, burst length, frame length or other repetitive signal characteristic.

Remote command:

TRIGger[:SEquence]:TIME:RINTerval on page 120

Drop-Out Time ← Trigger Source

Defines the time the input signal must stay below the trigger level before triggering again.

Note: For input from the Analog Baseband Interface (R&S FSW-B71) using the base-band power trigger (BBP), the default drop out time is set to 100 ns to avoid unintentional trigger events (as no hysteresis can be configured in this case).

Remote command:

TRIGger[:SEquence]:DTIME on page 115

Trigger Offset ← Trigger Source

Defines the time offset between the trigger event and the start of the sweep for the MSRA Master.

This setting is not available in MSRA application measurement channels. For applications, use the "Capture Offset" on page 62 instead.

offset > 0:	Start of the sweep is delayed
offset < 0:	Sweep starts earlier (pre-trigger) Maximum allowed range limited by the sweep time: $\text{pretrigger}_{\text{max}} = \text{sweep time}$

Remote command:

TRIGger[:SEquence]:HOLDoff[:TIME] on page 116

Hysteresis ← Trigger Source

Defines the distance in dB to the trigger level that the trigger source must exceed before a trigger event occurs. Setting a hysteresis avoids unwanted trigger events caused by noise oscillation around the trigger level.

This setting is only available for "IF Power" trigger sources. The range of the value is between 3 dB and 50 dB with a step width of 1 dB.

Remote command:

`TRIGger[:SEquence]:IFPower:HYSteresis` on page 116

Trigger Holdoff ← Trigger Source

Defines the minimum time (in seconds) that must pass between two trigger events. Trigger events that occur during the holdoff time are ignored.

Remote command:

`TRIGger[:SEquence]:IFPower:HOLDoFF` on page 116

Slope ← Trigger Source

For all trigger sources except time and frequency mask (Realtime only) you can define whether triggering occurs when the signal rises to the trigger level or falls down to it.

Remote command:

`TRIGger[:SEquence]:SLOPe` on page 118

Trigger 2/3

Defines the usage of the variable TRIGGER INPUT/OUTPUT connectors, where:

"Trigger 2": TRIGGER INPUT/OUTPUT connector on the front panel

"Trigger 3": TRIGGER 3 INPUT/ OUTPUT connector on the rear panel

(Trigger 1 is INPUT only.)

Note: Providing trigger signals as output is described in detail in the R&S FSW User Manual.

"Input" The signal at the connector is used as an external trigger source by the R&S FSW. No further trigger parameters are available for the connector.

"Output" The R&S FSW sends a trigger signal to the output connector to be used by connected devices.
Further trigger parameters are available for the connector.

Remote command:

`OUTPut:TRIGger<port>:LEVel` on page 121

`OUTPut:TRIGger<port>:DIRection` on page 120

Output Type ← Trigger 2/3

Type of signal to be sent to the output

"Device Trig- (Default) Sends a trigger when the R&S FSW triggers.
gered"

"Trigger Armed" Sends a (high level) trigger when the R&S FSW is in "Ready for trigger" state.
This state is indicated by a status bit in the `STATUS:OPERation` register (bit 5), as well as by a low level signal at the AUX port (pin 9).

"User Defined" Sends a trigger when user selects "Send Trigger" button.
In this case, further parameters are available for the output signal.

Remote command:

`OUTPut:TRIGger<port>:OTYPe` on page 121

Level ← Output Type ← Trigger 2/3

Defines whether a constant high (1) or low (0) signal is sent to the output connector.

Remote command:

`OUTPut:TRIGger<port>:LEVel` on page 121

Pulse Length ← Output Type ← Trigger 2/3

Defines the length of the pulse sent as a trigger to the output connector.

Remote command:

`OUTPut:TRIGger<port>:PULSe:LENGth` on page 122

Send Trigger ← Output Type ← Trigger 2/3

Sends a user-defined trigger to the output connector immediately. Note that the trigger pulse level is always opposite to the constant signal level defined by the output "Level" setting, e.g. for "Level = High", a constant high signal is output to the connector until the "Send Trigger" button is selected. Then, a low pulse is sent.

Which pulse level will be sent is indicated by a graphic on the button.

Remote command:

`OUTPut:TRIGger<port>:PULSe:IMMediate` on page 122

7.7 Data Acquisition and Bandwidth Settings

How data is to be acquired is configured in the "Bandwidth" dialog box.

- [Data Acquisition](#)..... 57
- [Sweep Settings](#)..... 62

7.7.1 Data Acquisition

The data acquisition settings define which parts of the input signal are captured for further evaluation in the applications. They are configured in the "Data Acquisition" tab of the "Bandwidth" dialog box.

► To display this dialog box, do one of the following:

- Select the "Bandwidth" button in the configuration "Overview"
- Select the BW key and then the "Data Acquisition" softkey.

- Select the "Data Acquisition" softkey in the "I/Q Analyzer" menu.

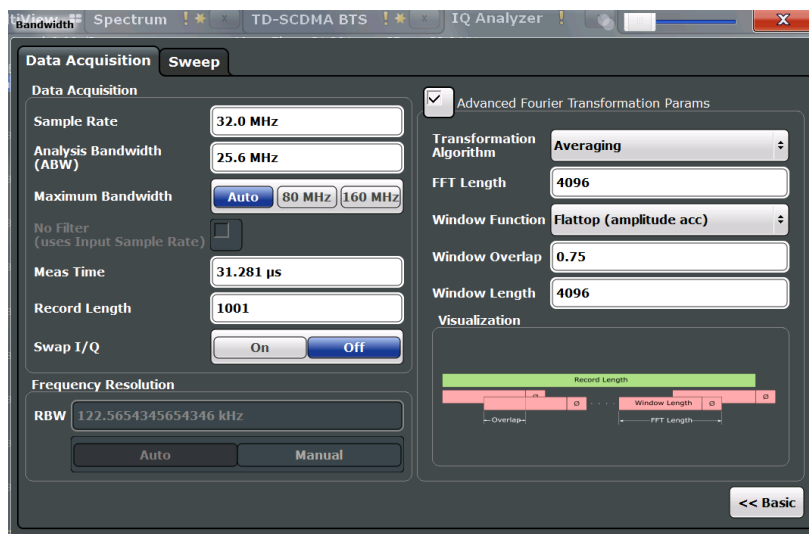

Fig. 7-2: Data acquisition settings with advanced FFT parameters



Configuring data acquisition is only possible for the MSRA Master channel. In I/Q Analyzer application channels, these settings define the analysis interval (see chapter 6.3, "Multi-Standard Analysis", on page 28). Be sure to select the correct measurement channel before changing these settings.

Sample Rate.....	58
Analysis Bandwidth.....	59
Maximum Bandwidth.....	59
Meas Time.....	59
Record Length.....	60
RBW.....	60
Advanced FFT mode / Basic settings.....	61
L Transformation Algorithm.....	61
L FFT Length.....	61
L Window Function.....	61
L Window Overlap.....	62
L Window Length.....	62
Capture Offset.....	62

Sample Rate

Defines the I/Q data sample rate of the R&S FSW. This value is dependent on the defined Analysis Bandwidth and the defined signal source.

Up to the Maximum Bandwidth, the following rule applies:

$$sample\ rate = analysis\ bandwidth / 0.8$$

For details on the dependencies see chapter A.3, "Sample Rate and Maximum Usable I/Q Bandwidth for RF Input", on page 150.

In particular, note the irregularity mentioned in [chapter A.3.2, "Max. Sample Rate and Bandwidth with Activated I/Q Bandwidth Extension Option B500"](#), on page 155.

Remote command:

`TRACe: IQ:SRATe` on page 127

Analysis Bandwidth

Defines the flat, usable bandwidth of the final I/Q data. This value is dependent on the defined [Sample Rate](#) and the defined signal source.

Up to the [Maximum Bandwidth](#), the following rule applies:

*analysis bandwidth = 0.8 * sample rate*

Note: For input from the **Analog Baseband interface (R&S FSW-B71)**: If the frequency range defined by the analysis bandwidth and the center frequency exceeds the minimum frequency (0 Hz for low IF evaluation) or the maximum frequency (for I+jQ evaluation), an error is displayed. In this case, adjust the center frequency (see ["Center Frequency"](#) on page 41) or the analysis bandwidth to exclude possible unwanted signal components.

Remote command:

`TRACe: IQ:BWIDth` on page 126

Maximum Bandwidth

Defines the maximum bandwidth to be used by the R&S FSW for I/Q data acquisition. This setting is only available if the bandwidth extension option R&S FSW-B160/-B320/-B500 is installed. Otherwise the maximum bandwidth is determined automatically.

For details on the maximum bandwidth see [chapter A.3, "Sample Rate and Maximum Usable I/Q Bandwidth for RF Input"](#), on page 150.

"Auto"	(Default) All installed bandwidth extension options are activated. The currently available maximum bandwidth is allowed (see chapter A.3, "Sample Rate and Maximum Usable I/Q Bandwidth for RF Input" , on page 150). Note that using bandwidth extension options R&S FSW-B160/-B320 may cause more spurious effects (option B500 does not).
"80 MHz"	Restricts the analysis bandwidth to a maximum of 80 MHz. The bandwidth extension options R&S FSW-B160/-B320/-B500 are deactivated.
"160 MHz"	Restricts the analysis bandwidth to a maximum of 160 MHz. The bandwidth extension option R&S FSW-B320 is deactivated. (Not available or required if bandwidth extension option R&S FSW-B500 is installed.)

Remote command:

`TRACe: IQ:WBANd[:STATe]` on page 128

`TRACe: IQ:WBANd:MBWIDTH` on page 128

Meas Time

Defines the I/Q acquisition time. By default, the measurement time is calculated as the number of I/Q samples ("Record Length") divided by the sample rate. If you change the measurement time, the [Record Length](#) is automatically changed, as well.

For details on the maximum number of samples see also [chapter A.3, "Sample Rate and Maximum Usable I/Q Bandwidth for RF Input"](#), on page 150.

Remote command:

`[SENSe:] SWEep:TIME` on page 136

Record Length

Defines the number of I/Q samples to record. By default, the number of sweep points is used. The record length is calculated as the measurement time multiplied by the sample rate. If you change the record length, the [Meas Time](#) is automatically changed, as well.

Note: For the I/Q vector result display, the number of I/Q samples to record ("Record Length") must be identical to the number of trace points to be displayed ("Sweep Points"). Thus, the sweep points are not editable for this result display. If the "Record Length" is edited, the sweep points are adapted automatically.

For record lengths outside the valid range of sweep points, i.e. less than 101 points or more than 100001 points, the diagram does not show valid results.

Remote command:

`TRACe:IQ:RLENgth` on page 126

RBW

Defines the resolution bandwidth. The maximum RBW corresponds to the [Analysis Bandwidth](#). The minimum RBW depends on the sample rate.

Depending on the selected RBW mode, the value is either determined automatically or can be defined manually. As soon as you enter a value in the input field, the RBW mode is changed to "Manual".

If the "Advanced Fourier Transformation Params" option is enabled, advanced FFT mode is selected and the RBW cannot be defined directly.

Note that the RBW is correlated with the [Sample Rate](#) and [Record Length](#) (and possibly the [Window Function](#) and [Window Length](#)). Changing any one of these parameters may cause a change to one or more of the other parameters.

For more information see the "Basics on FFT" section of the R&S FSW I/Q Analyzer and I/Q Input User Manual.

- | | |
|---------------------|--|
| "Auto mode" | (Default) The RBW is determined automatically depending on the Sample Rate and Record Length . |
| "Manual mode" | The RBW can be defined by the user. The maximum RBW corresponds to the Analysis Bandwidth . The minimum RBW depends on the sample rate.
The user-defined RBW is used and the Window Length (and possibly Sample Rate) are adapted accordingly. |
| "Advanced FFT mode" | This mode is used if the "Advanced Fourier Transformation Params" option is enabled.
The RBW is determined by the advanced FFT parameters . |

Remote command:

`[SENSe:] IQ:BANDwidth|BWIDth:MODE` on page 123

`[SENSe:] IQ:BANDwidth|BWIDth:RESolution` on page 123

Advanced FFT mode / Basic settings

Shows or hides the "Advanced Fourier Transformation" parameters in the "Data Acquisition" dialog box. These parameters are only available and required for the advanced FFT mode.

For more information see the "Basics on FFT" section of the R&S FSW I/Q Analyzer and I/Q Input User Manual.

Transformation Algorithm ← Advanced FFT mode / Basic settings

Defines the FFT calculation method.

- | | |
|-------------|---|
| "Single" | One FFT is calculated for the entire record length; if the FFT Length is larger than the record length, zeros are appended to the captured data. |
| "Averaging" | Several overlapping FFTs are calculated for each record; the results are combined to determine the final FFT result for the record. The number of FFTs to be averaged is determined by the Window Overlap and the Window Length . |

Remote command:

[\[SENSe:\] IQ:FFT:ALGORITHM](#) on page 124

FFT Length ← Advanced FFT mode / Basic settings

Defines the number of frequency points determined by each FFT calculation. The more points are used, the higher the resolution in the spectrum becomes, but the longer the calculation takes.

In advanced FFT mode, the number of sweep points is set to the FFT length automatically.

Note: If you use the arrow keys or the rotary knob to change the FFT length, the value is incremented or decremented by powers of 2.

If you enter the value manually, any integer value from 3 to 524288 is available.

Remote command:

[\[SENSe:\] IQ:FFT:LENGTH](#) on page 124

Window Function ← Advanced FFT mode / Basic settings

In the I/Q analyzer you can select one of several FFT window types.

The following window types are available:

- Blackman-Harris
- Flattop
- Gauss
- Rectangular
- 5-Term

Remote command:

[\[SENSe:\] IQ:FFT:WINDOW:TYPE](#) on page 125

Window Overlap ← **Advanced FFT mode / Basic settings**

Defines the part of a single FFT window that is re-calculated by the next FFT calculation when using multiple FFT windows.

Remote command:

[SENSe:] IQ:FFT:WINDow:OVERlap on page 125

Window Length ← **Advanced FFT mode / Basic settings**

Defines the number of samples to be included in a single FFT window in averaging mode. (In single mode, the window length corresponds to the "Record Length" on page 60.)

Values from 3 to 524288 are available, however, the window length may not be longer than the [FFT Length](#).

Remote command:

[SENSe:] IQ:FFT:WINDow:LENGth on page 125

Capture Offset

This setting is only available for applications in **MSRA operating mode**. It has a similar effect as the trigger offset in other measurements: it defines the time offset between the capture buffer start and the start of the extracted application data.

In MSRA mode, the offset must be a positive value, as the capture buffer starts at the trigger time = 0.

For more information see "[Trigger offset vs. capture offset](#)" on page 29.

Remote command:

[SENSe:] MSRA:CAPTure:OFFSet on page 146

7.7.2 Sweep Settings

The sweep settings are configured via the SWEEP key or in the "Sweep" tab of the "Bandwidth" dialog box.

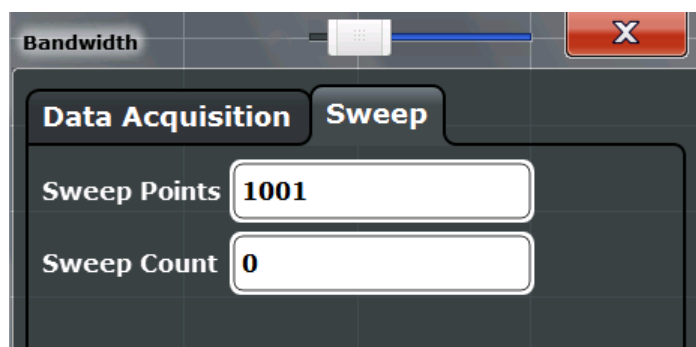

- ▶ To display this dialog box, do one of the following:
 - Select the "Bandwidth" button in the configuration "Overview" and switch to the "Sweep" tab.
 - Select the SWEEP key and then the "Sweep Config" softkey.

For background information on performing sweeps in MSRA mode see [chapter 6.2, "Data Acquisition"](#), on page 27.

Sweep Points.....	63
Refresh.....	63
Continuous Sweep/RUN CONT.....	63
Single Sweep/ RUN SINGLE.....	64
Continue Single Sweep.....	64

Sweep Points

In the I/Q Analyzer application, a specific frequency bandwidth is swept for a specified measurement time. During this time, a defined number of samples (= "Record Length") are captured. These samples are then evaluated by the applications. Therefore, in this case the number of sweep points does not define the amount of data to be acquired, but rather the number of trace points that are evaluated and displayed in the result diagrams.

Note: As opposed to previous versions of the I/Q Analyzer, the sweep settings are now window-specific. For some result displays, the sweep points may not be editable as they are determined automatically, or restrictions may apply.

For the I/Q vector result display, the number of I/Q samples to record ("Record Length") must be identical to the number of trace points to be displayed ("Sweep Points"). Thus, the sweep points are not editable for this result display. If the "Record Length" is edited, the sweep points are adapted automatically. For record lengths outside the valid range of sweep points, i.e. less than 101 points or more than 32001 points, the diagram does not show valid results.

Using fewer than 4096 sweep points with a detector other than Auto Peak may lead to wrong level results.

Remote command:

[SENSe:] SWEep: POINTs on page 136

Refresh

This function is only available if the Sequencer is deactivated and only for **MSRA applications**.

The data in the capture buffer is re-evaluated by the currently active application only. The results for any other applications remain unchanged.

This is useful, for example, after evaluation changes have been made or if a new sweep was performed from another application; in this case, only that application is updated automatically after data acquisition.

Note: To update all active applications at once, use the "Refresh all" function in the "Sequencer" menu.

Remote command:

INITiate: REFresh on page 146

Continuous Sweep/RUN CONT

After triggering, initiates data acquisition continuously until stopped. If the Sequencer is off, only the evaluation for the currently displayed measurement channel is updated.

While the measurement is running, the "Continuous Sweep" softkey and the RUN CONT key are highlighted. The running measurement can be aborted by selecting the highlighted softkey or key again. The results are not deleted until a new measurement is started.

Note: Sequencer. If the Sequencer is active, the "Continuous Sweep" softkey only controls the sweep mode for the currently selected channel; however, the sweep mode only has an effect the next time the Sequencer activates that channel, and only for a channel-defined sequence. In this case, a channel in continuous sweep mode is swept repeatedly.

Furthermore, the RUN CONT key on the front panel controls the Sequencer, not individual sweeps. RUN CONT starts the Sequencer in continuous mode.

For details on the Sequencer, see the R&S FSW User Manual.

Remote command:

`INITiate:CONTinuous` on page 134

Single Sweep/ RUN SINGLE

After triggering, starts a single data acquisition. If the Sequencer is off, only the evaluation for the currently displayed measurement channel is updated.

While the measurement is running, the "Single Sweep" softkey and the RUN SINGLE key are highlighted. The running measurement can be aborted by selecting the highlighted softkey or key again.

Note: Sequencer. If the Sequencer is active, the "Single Sweep" softkey only controls the sweep mode for the currently selected channel; however, the sweep mode only has an effect the next time the Sequencer activates that channel, and only for a channel-defined sequence. In this case, a channel in single sweep mode is swept only once by the Sequencer.

Furthermore, the RUN SINGLE key on the front panel controls the Sequencer, not individual sweeps. RUN SINGLE starts the Sequencer in single mode.

If the Sequencer is off, only the evaluation for the currently displayed measurement channel is updated.

Remote command:

`INITiate[:IMMEDIATE]` on page 134

Continue Single Sweep

After triggering, repeats data acquisition without deleting the trace of the last measurement. If the Sequencer is off, only the evaluation for the currently displayed measurement channel is updated.

While the measurement is running, the "Continue Single Sweep" softkey and the RUN SINGLE key are highlighted. The running measurement can be aborted by selecting the highlighted softkey or key again.

Remote command:

`INITiate:CONMeas` on page 133

7.8 Output Settings

The R&S FSW can provide output to special connectors for other devices.

For details on connectors refer to the R&S FSW Getting Started manual, "Front / Rear Panel View" chapters.



How to provide trigger signals as output is described in detail in the R&S FSW User Manual.

Output settings can be configured via the INPUT/OUTPUT key or in the "Outputs" dialog box.



Noise Source.....	65
Trigger 2/3.....	65
L Output Type.....	66
L Level.....	66
L Pulse Length.....	66
L Send Trigger.....	66

Noise Source

Switches the supply voltage for an external noise source on or off.

External noise sources are useful when you are measuring power levels that fall below the noise floor of the R&S FSW itself, for example when measuring the noise level of a DUT.

Remote command:

[DIAGnostic:SERvice:NSource](#) on page 114

Trigger 2/3

Defines the usage of the variable TRIGGER INPUT/OUTPUT connectors, where:

"Trigger 2": TRIGGER INPUT/OUTPUT connector on the front panel

"Trigger 3": TRIGGER 3 INPUT/ OUTPUT connector on the rear panel
(Trigger 1 is INPUT only.)

Note: Providing trigger signals as output is described in detail in the R&S FSW User Manual.

"Input" The signal at the connector is used as an external trigger source by the R&S FSW. No further trigger parameters are available for the connector.

"Output" The R&S FSW sends a trigger signal to the output connector to be used by connected devices.
Further trigger parameters are available for the connector.

Remote command:

[OUTPut:TRIGger<port>:LEVel](#) on page 121

[OUTPut:TRIGger<port>:DIRection](#) on page 120

Output Type ← Trigger 2/3

Type of signal to be sent to the output

"Device Trig- (Default) Sends a trigger when the R&S FSW triggers.
gered"

"Trigger Sends a (high level) trigger when the R&S FSW is in "Ready for trig-
Armed" ger" state.
This state is indicated by a status bit in the `STATUS:OPERation` register (bit 5), as well as by a low level signal at the AUX port (pin 9).

"User Defined" Sends a trigger when user selects "Send Trigger" button.
In this case, further parameters are available for the output signal.

Remote command:

[OUTPut:TRIGger<port>:OTYPe](#) on page 121

Level ← Output Type ← Trigger 2/3

Defines whether a constant high (1) or low (0) signal is sent to the output connector.

Remote command:

[OUTPut:TRIGger<port>:LEVel](#) on page 121

Pulse Length ← Output Type ← Trigger 2/3

Defines the length of the pulse sent as a trigger to the output connector.

Remote command:

[OUTPut:TRIGger<port>:PULSe:LENGth](#) on page 122

Send Trigger ← Output Type ← Trigger 2/3

Sends a user-defined trigger to the output connector immediately. Note that the trigger pulse level is always opposite to the constant signal level defined by the output "Level" setting, e.g. for "Level = High", a constant high signal is output to the connector until the "Send Trigger" button is selected. Then, a low pulse is sent.

Which pulse level will be sent is indicated by a graphic on the button.

Remote command:

[OUTPut:TRIGger<port>:PULSe:IMMediate](#) on page 122

7.9 Display Configuration

The captured signal can be displayed using various evaluation methods. All evaluation methods available for the current application are displayed in the evaluation bar in SmartGrid mode when you do one of the following:

- Select the  "SmartGrid" icon from the toolbar.
- Select the "Display Config" button in the "Overview".
- Press the MEAS key.
- Select the "Display Config" softkey in the main application menu.

Up to 6 evaluations can be displayed in the I/Q Analyzer and thus in the MSRA Master at any time, including several graphical diagrams, marker tables or peak lists.

For a description of the available evaluation methods see the "Measurements and Result Displays" topic of the corresponding application User Manual.

7.10 Automatic Settings

Some settings can be adjusted by the R&S FSW automatically according to the current measurement settings.

To activate the automatic adjustment of a setting, select the corresponding function in the AUTO SET menu or in the configuration dialog box for the setting, where available.



Settings related to data acquisition (measurement time, hysteresis) can only be adjusted in the MSRA Master, not in the applications.

Adjusting all Determinable Settings Automatically (Auto All).....	67
Adjusting the Center Frequency Automatically (Auto Freq).....	67
Setting the Reference Level Automatically (Auto Level).....	68
Resetting the Automatic Measurement Time (Meastime Auto).....	68
Changing the Automatic Measurement Time (Meastime Manual).....	68
Upper Level Hysteresis.....	68
Lower Level Hysteresis.....	69

Adjusting all Determinable Settings Automatically (Auto All)

Activates all automatic adjustment functions for the current measurement settings.

This includes:

- [Auto Level](#)

This function is only available for the MSRA/MSRT Master, not for the applications.

Remote command:

`[SENSe:]ADJust:ALL` on page 129

Adjusting the Center Frequency Automatically (Auto Freq)

This function adjusts the center frequency automatically.

The optimum center frequency is the frequency with the highest S/N ratio in the frequency span. As this function uses the signal counter, it is intended for use with sinusoidal signals.

Remote command:

`[SENSe:]ADJust:FREQuency` on page 131

Setting the Reference Level Automatically (Auto Level)

Automatically determines the optimal reference level for the current input data. At the same time, the internal attenuators and the preamplifier (for analog baseband input: the full scale level) are adjusted so the signal-to-noise ratio is optimized, while signal compression, clipping and overload conditions are minimized.

In order to do so, a level measurement is performed to determine the optimal reference level.

This function is only available for the MSRA/MSRT Master, not for the applications.

You can change the measurement time for the level measurement if necessary (see "[Changing the Automatic Measurement Time \(Meastime Manual\)](#)" on page 68).

Remote command:

`[SENSe:]ADJust:LEVel` on page 132

Resetting the Automatic Measurement Time (Meastime Auto)

Resets the measurement duration for automatic settings to the default value.

This function is only available for the MSRA/MSRT Master, not for the applications.

Remote command:

`[SENSe:]ADJust:CONFigure:DURation:MODE` on page 130

Changing the Automatic Measurement Time (Meastime Manual)

This function allows you to change the measurement duration for automatic setting adjustments. Enter the value in seconds.

This function is only available for the MSRA/MSRT Master, not for the applications.

Remote command:

`[SENSe:]ADJust:CONFigure:DURation:MODE` on page 130

`[SENSe:]ADJust:CONFigure:DURation` on page 130

Upper Level Hysteresis

When the reference level is adjusted automatically using the [Auto Level](#) function, the internal attenuators and the preamplifier are also adjusted. In order to avoid frequent adaptation due to small changes in the input signal, you can define a hysteresis. This setting defines an upper threshold the signal must exceed (compared to the last measurement) before the reference level is adapted automatically.

This function is only available for the MSRA/MSRT Master, not for the applications.

Remote command:

`[SENSe:]ADJust:CONFigure:HYSTeresis:UPPer` on page 131

Lower Level Hysteresis

When the reference level is adjusted automatically using the [Auto Level](#) function, the internal attenuators and the preamplifier are also adjusted. In order to avoid frequent adaptation due to small changes in the input signal, you can define a hysteresis. This setting defines a lower threshold the signal must fall below (compared to the last measurement) before the reference level is adapted automatically.

This function is only available for the MSRA/MSRT Master, not for the applications.

Remote command:

`[SENSe:]ADJust:CONFigure:HYSTeresis:LOWer` on page 131

8 Analysis

The data that was captured by the MSRA Master can be analyzed in various different applications.

The analysis settings and functions available in MSRA mode are those described for the individual applications. The MSRA Master is in effect an I/Q Analyzer application and has the same analysis functions and settings.

See the R&S FSW I/Q Analyzer User Manual for a description of the analysis functions and settings available for the I/Q Analyzer and thus the MSRA master.

Configuring the application data extract and analysis interval

The settings required to configure the application data extract or analysis intervals vary depending on the application. See the corresponding application manuals for details.

For the I/Q Analyzer, the settings are the same as those used to define the actual data acquisition (see [chapter 7.7.1, "Data Acquisition"](#), on page 57. In MSRA application channels, they define the analysis interval. Be sure to select the correct measurement channel before executing these commands.



Exporting I/Q Data

The captured I/Q data from the MSRA Master can be exported for further analysis in external applications.

The export functions are available in the "Save/Recall" menu which is displayed when you select the "Save" or "Open" icon in the toolbar.

For details on exporting I/Q data see the R&S FSW I/Q Analyzer User Manual.

8.1 Configuring the Analysis Line

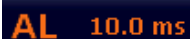

To hide or show and position the analysis line, a dialog box is available. To display the "Analysis Line" dialog box, select the "AL" icon in the toolbar (only available in MSRA mode). The current position of the analysis line is indicated on the icon.

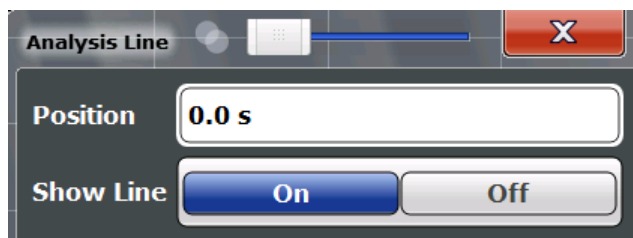

Position.....	71
Show Line.....	71

Position

Defines the position of the analysis line in the time domain. The position must lie within the measurement time of the multistandard measurement.

Remote command:

`CALCulate:MSRA:ALINE[:VALue]` on page 145

Show Line

Hides or displays the analysis line in the time-based windows. By default, the line is displayed.

Note: even if the analysis line display is off, the indication whether or not the currently defined line position lies within the analysis interval of the active application remains in the window title bars.

Remote command:

`CALCulate:MSRA:ALINE:SHOW` on page 145

9 How to Perform Measurements in MSRA Mode

The following step-by-step instructions demonstrate how to perform a measurement in MSRA mode.

How to capture I/Q data in MSRA mode

1. Press the MODE key on the front panel and select the "MSRA" operating mode. Confirm the message.
2. Select the "Overview" softkey to display the "Overview" for an MSRA measurement.
3. Select the "Input" button to select the input signal source.
4. Select the "Amplitude" button to define the attenuation, reference level or other settings that affect the input signal's amplitude and scaling.
5. Select the "Frequency" button to define the input signal's center frequency.
6. Optionally, select the "Trigger" button and define a trigger for data acquisition, for example an IQ Power trigger to start capturing data only when a specific power is exceeded.
7. Select the "Bandwidth" button and define the bandwidth parameters for data acquisition:
 - "Sample rate" or "Analysis Bandwidth:" the span of the input signal to be captured for analysis, or the rate at which samples are captured (both values are correlated)
 - Optionally, if a bandwidth extension (> 160 MHz) is installed, the "Maximum Bandwidth", depending on whether you require a larger bandwidth or fewer spurious emissions.
 - "Measurement Time:" how long the data is to be captured
 - "Record Length": the number of samples to be captured (also defined by sample rate and measurement time)
8. If necessary, select the "Display Config" button and select other displays (up to a total of 6) required to control the acquired data. Arrange them on the display to suit your preferences.
9. Exit the SmartGrid mode.
10. Optionally, stop continuous measurement mode by the Sequencer and perform a single data acquisition:
 - a) Select the Sequencer icon () from the toolbar.
 - b) Set the Sequencer state to "OFF".
 - c) Press the RUN SINGLE key.

11. Optionally, export the captured or analyzed I/Q data (depending on the active channel) to a file.
 - a) Select the  "Save" icon in the toolbar.
 - b) Select the "I/Q Export" softkey.
 - c) Define a file name and storage location and select "Save".

The captured data is stored to a file with the extension `.iq.tar`.

Now you can analyze the captured I/Q data in various MSRA applications at the same time.

How to analyze the captured I/Q data in MSRA applications

1. Press the MODE key on the front panel and select an MSRA application.
2. Select the "Overview" softkey to display the "Overview" for the MSRA application.
3. Define the application data extract, i.e. the range of the capture buffer you want to analyze in this application.
4. Define the analysis interval, i.e. the frame number or similar within the application data you want to analyze in this application (not necessary for I/Q Analyzer or Analog Demodulation applications).
5. Select the "Frequency" button and define the center frequency for the analysis interval.
6. Select the "Display Config" button and select other displays (up to a total of 6) to analyze the data in the configured interval.
Arrange them on the display to suit your preferences.
7. Exit the SmartGrid mode.
Repeat these steps for any other applications.

How to perform multi-standard analysis of the I/Q data

1. Perform a single I/Q data acquisition measurement as described in ["How to capture I/Q data in MSRA mode"](#) on page 72.
2. Activate measurement channels for the MSRA applications you require as described in ["How to analyze the captured I/Q data in MSRA applications"](#) on page 73.
3. Select the MSRA View to get an overview of the captured data and the configured applications.
Determine the individual data ranges that are relevant for a specific standard. If necessary, adapt the application data and analysis interval settings for the applications to reflect the relevant data ranges.
4. If the results indicate that dependencies between different standards in the signal may exist:
 - a) Select the application in which unusual data occurs.

- b) If necessary, perform a new data acquisition.
- c) Determine the bandwidth or measurement time of the unusual data.
- d) Select the MSRA View to compare the data with the other standard applications.
If a specific event (e.g. a burst, spur etc.) occurs in another standard at the same time as the unusual data in the first application, the two effects may be correlated.
- e) Select the possibly dependant standard application.
- f) Define an analysis interval for the conspicuous data range (as described in ["How to analyze the captured I/Q data in MSRA applications"](#) on page 73).
- g) Refresh the result display for the changed analysis interval ("Sweep" menu).

Now you can analyze the data in detail to determine the cause of the unusual signal behavior.

How to perform a measurement in the time or frequency domain in MSRA mode

1. Capture I/Q data with the MSRA Master as described in ["How to capture I/Q data in MSRA mode"](#) on page 72.
2. Activate an "I/Q Analyzer" channel as an MSRA application as described in ["How to analyze the captured I/Q data in MSRA applications"](#) on page 73.
3. In the I/Q Analyzer application, press the MEAS key on the front panel of the R&S FSW.
4. From the "Select Measurement" dialog box, select the required measurement in the time or frequency domain.
5. Configure the measurement as described in the R&S FSW User Manual.
The I/Q data captured by the MSRA Master is analyzed in the time or frequency domain, according to the selected measurement and result displays.
6. To switch back to a conventional I/Q analysis, press the MEAS key on the front panel of the R&S FSW and select the "IQ Analyzer" measurement.

10 Measurement Example: Analyzing MSR Signals

Using the MSRA, you can examine crosstalk between different radio access technologies (RAT) sent out from a base station at the same time. Furthermore, you can determine any signal interference between two or more carriers due to time correlation, as you can analyze the same signal data (captured at exactly the same time) in various applications.

The following measurement example demonstrates how to capture data from a signal with 4 carriers using different standards (GSM, WCDMA, LTE, GSM) and then analyze the data in the MSRA operating mode using the I/Q Analyzer and the 3GPP FDD BTS application.

Measurement setup

The measurements are performed using the following instruments and accessories:

- The R&S FSW with application firmware R&S FSW-K72: 3GPP FDD BTS Measurements
- A Vector Signal Generator:
R&S SMU (with options R&S SMU-K240 Dig. Std GSM/EDGE, SMU-K242 Dig. Std 3GPP FDD, SMU-K255 Dig. Std EUTRA)
or
R&S SMBV (with options R&S SMBV -K240 Dig. Std GSM/EDGE, SMBV-K242 Dig. Std 3GPP FDD, SMBV-K255 Dig. Std EUTRA)
(The vector signal generator is referred to as *SMx* in the example.)
- 1 coaxial cable, 50Ω, approx. 1 m, N connector
- 1 coaxial cable, 50Ω, approx. 1 m, BNC connector

To set up the instruments

1. Connect the "RF output" of the SMx to the RF INPUT connector on the front panel of the R&S FSW (coaxial cable with an N connector).
2. Connect the "Marker1" output of the SMx to the TRIGGER INPUT connector on the front panel of the R&S FSW (coaxial cable with a BNC connector).

Preparation

The waveform of the described multi-standard signal is provided in the following file on the R&S FSW:

```
C:\R_S\Instr\user\Waveforms\MSRA_GSM_WCDMA_LTE_GSM.wv
```

The signal is described in the `Readme.txt` file in the same folder.

- ▶ Copy the file from the R&S FSW to the SMx using a USB stick, for example.

Settings on the R&S SMx

1. Press the PRESET key to reset the instrument.
2. Press the FREQ key and set the frequency to *1 GHz*.
3. Press the LEVEL key and set the level to *0 dBm*.
4. Press the RF ON/OFF key to switch the RF on.
5. Press the DIAGRAM key and then select "Load Waveform" to load the signal data from the provided file. From the drive for the USB stick, select the file
`C:\R_S\Instr\user\Waveforms\MSRA_GSM_WCDMA_LTE_GSM.wv`.
6. Select the "Trigger/Marker" menu and set "Marker1" to "Restart". Press the ESC key to close the dialog box.
7. Switch the "State" button to "ON" to activate the waveform.

Settings on the R&S FSW

1. Press the PRESET key to preset the R&S FSW.
2. Press the MODE key and select the "Multi-Standard Radio Analyzer" tab. Confirm the message to switch to MSRA mode.
3. Press the FREQ key and set the "Center Frequency" to *1 GHz*.
4. Press the AMPT key and set the reference level to *10 dBm*.
5. Press the TRIG key and select "External Trigger 1" to use the external trigger from the SMU.
6. Press the MEAS CONFIG key, select the "Data Acquisition" softkey and set the "Sample Rate" to *15 MHz*.

Since the R&S FSW is set to continuous sweep mode by default, data acquisition is started automatically. The spectrum of the stored MSR signal from the file is displayed in the "MSRA Master" tab.

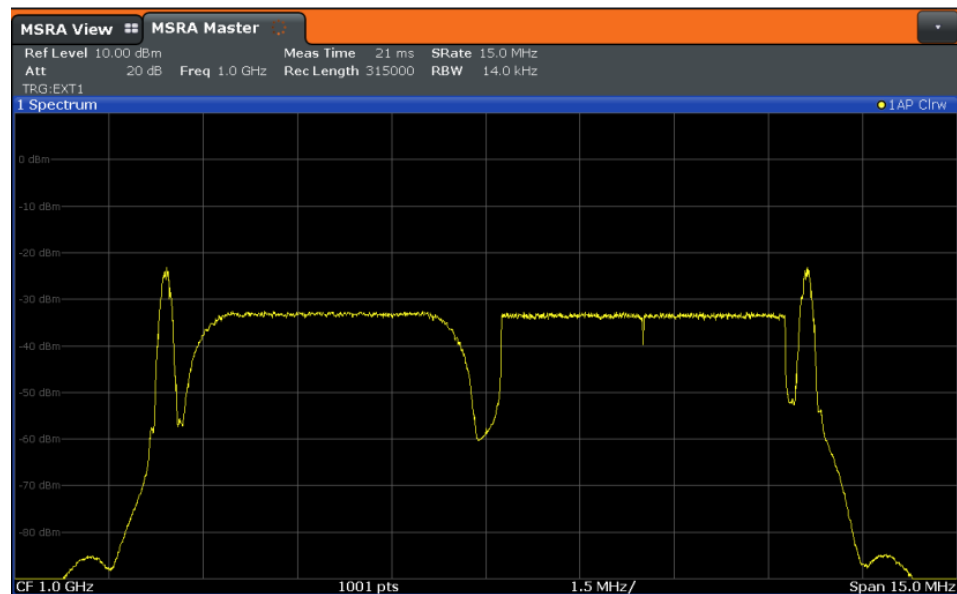

To analyze the GSM signal

Activate an I/Q Analyzer to analyze the GSM signal in more detail. Only the area around the first carrier is of interest.

1. Press the MODE key and select the "I/Q Analyzer" button.
2. Press the FREQ key and set the center frequency to *994.9 MHz*.
3. Press the MEAS CONFIG key, select the "Data Acquisition" softkey and set the "Sample Rate" to *1 MHz*.
4. Set the "Meas Time" to *5 ms*.

The I/Q Analyzer obtains an extract of the data captured by the MSRA Master. Which spectrum of the captured data is analyzed is indicated by vertical blue lines in the MSRA Master window (see [figure 10-1](#)).

To analyze the WCDMA signal

Activate a measurement channel for the 3GPP FDD BTS application to analyze the WCDMA signal in more detail. Now the second carrier is of interest.

1. Press the MODE key and select the "3GPP FDD BTS" button.
2. Press the FREQ key and set the center frequency to *997.5 MHz*.
The 3GPP FDD BTS application obtains an extract of the data captured by the MSRA Master.
3. Select the "MSRA View" tab to see the captured data and the GSM and WCDMA results at once.

Which spectrum of the captured data is analyzed is indicated by vertical blue lines in the "MSRA Master" window.



Fig. 10-1: MSRA View for I/Q Analyzer and 3GPP FDD BTS applications

4. Select the "3GPP FDD BTS" tab to return to the detailed WCDMA results.
5. Display the composite EVM of the WCDMA carrier:
 - a) Press the MEAS CONFIG key, then select the "Display Config" softkey.
 - b) Scroll through the result display buttons until you see "Composite EVM", then drag the button to the diagram area of the display.
The "Code Domain Power" display is replaced by the "Composite EVM" display.
 - c) Select the red cross at the top of the result display list (X) to close the Smart-Grid mode.
6. To optimize the diagram display, press the AUTO SET key and select "Auto Scale Window".

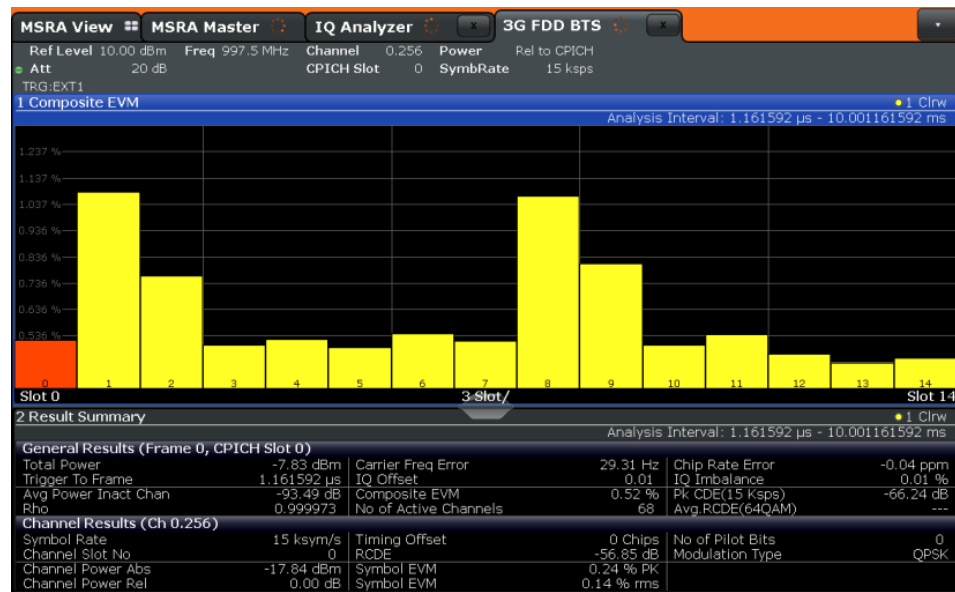

Fig. 10-2: Composite EVM of the WCDMA carrier

The slots 1, 2, 8, and 9 show a much higher EVM than the other slots.

7. Analyze the EVM for the chips in these slots:
 - a) Press the MEAS CONFIG key, then select the "Display Config" softkey.
 - b) Drag the "EVM vs Chip" button over the "Result Summary" beneath the "Composite EVM" display to replace it.
 - c) Select the red cross at the top of the result display list (✕) to close the Smart-Grid mode.

The EVM vs Chip results are displayed for slot 0.

8. Take a closer look at slot 1, which had a high EVM:
 - a) Select the "Evaluation Range" softkey and set the "Slot" to 1.
Slot 1 is highlighted red in the Composite EVM display.
 - b) Select the "EVM vs Chip" window to set the focus on it.
The EVM for the individual chips in slot 1 is displayed.
Note the **analysis interval** displayed in the window title bar, which indicates that the data displayed in the "EVM vs Chip" window was captured in the time interval 667 μs to 1.3 ms (referred to the absolute time of the I/Q signal captured with the MSRA Master).
 - c) Press the PEAK SEARCH key to place Marker1 on the chip with the highest EVM in slot 1.

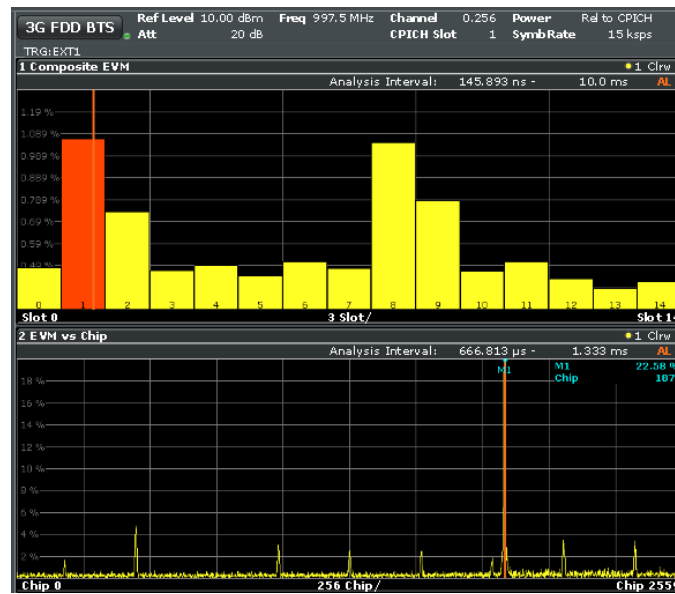

Fig. 10-3: Determining the chip with the highest EVM in a WCDMA slot

To determine time correlations in the MSR signal

You can use the analysis line to mark an occurrence in time in one application and see the same moment in time in another application, and thus find the source of irregularities.

1. Select the "I/Q Analyzer" tab.
2. Select the **AL 10.0 ms** icon in the toolbar and move the analysis line (either using the rotary knob or by dragging the line on the screen) until it reaches the irregular EVM in the "EVM vs Chip" display. The new position of the analysis line in the example is *1.156ms*.

If you switch to the IQ Analyzer and regard the "Magnitude" display, you see that the analysis line is on the rising edge of the GSM burst.

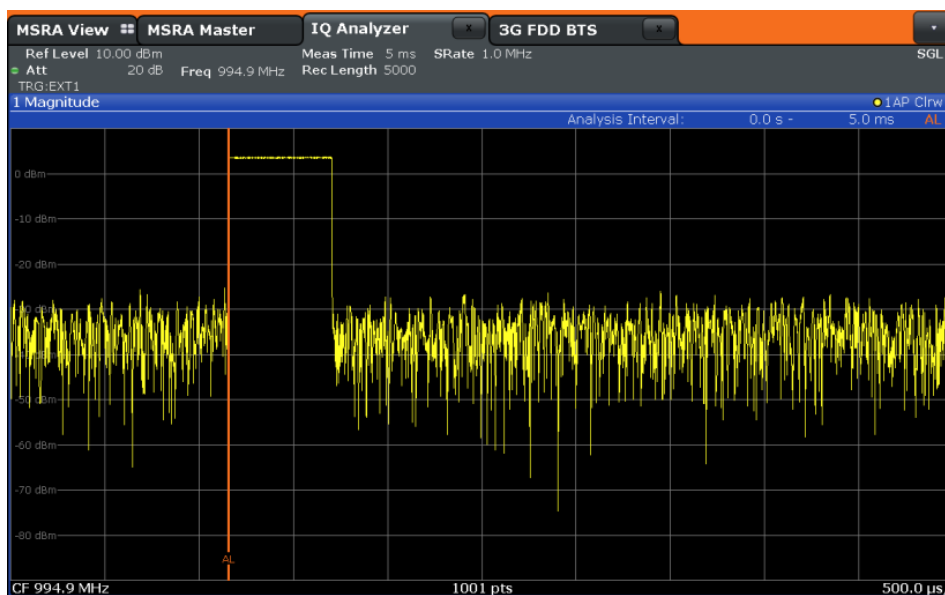

Fig. 10-4: Correlating events in an MSR signal

You can assume the GSM burst had an effect on the WCDMA carrier, causing an error.

Conclusion of the measurement example

In MSRA mode it is very easy to find crosstalk between different carriers by detecting time correlations between different signals, since the analysis is performed on the same recorded I/Q data. This is especially easy to detect using the analysis line in the MSRA View, as the time of a particular event is visible in the captured data and all individual application windows at once.



Fig. 10-5: MSRA View of MSR signal with time correlations



Capturing and analyzing long data sequences

The MSRA also allows you to capture very long data sequences. In order to examine particular areas of the large I/Q memory, each MSRA application supports a "Capture Offset" setting (TRIG menu, or "Data acquisition"/"Signal Capture" dialog box).

In the "MSRA Master" tab, the vertical blue lines in the "Magnitude" result display indicate which time interval of the I/Q data is analyzed by the individual applications. In this example, 40 ms are captured, the 3GPP FDD BTS application starts analysis at a Capture Offset of 20 ms (5 divisions with 4.0 ms/div), and the I/Q Analyzer starts with an offset of 31.5 ms.

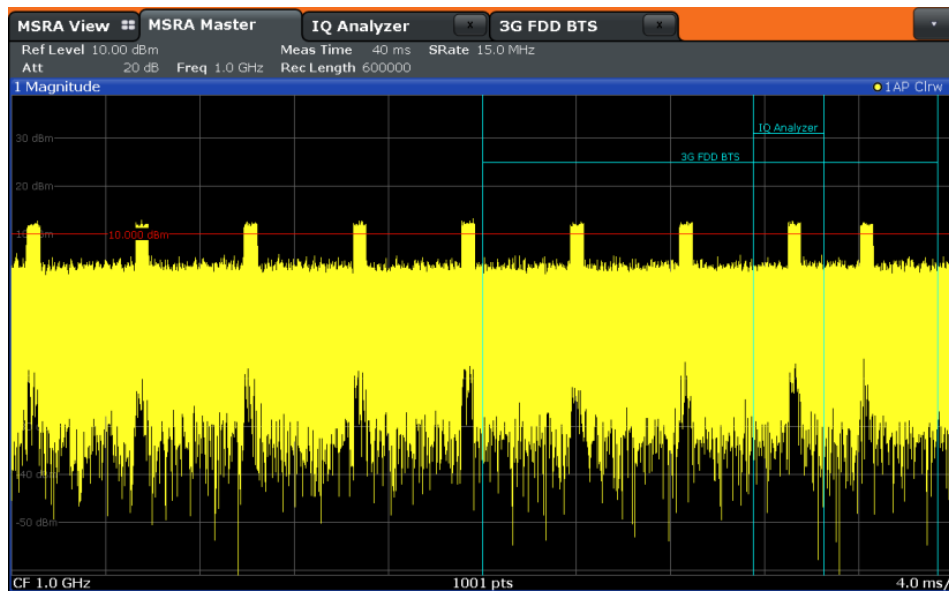

11 Remote Commands to Perform Measurements in MSRA Mode

The following commands are specific to performing measurements in MSRA mode in a remote environment. Generally, the remote commands are identical to those used in Spectrum mode as described in the R&S FSW User Manual. However, some restrictions or conditions may apply to specific commands (see also [chapter 6, "MSRA Basics"](#), on page 26).



You must always switch to MSRA mode before executing any MSRA-specific commands (using `INST:MODE MSR`).

It is assumed that the R&S FSW has already been set up for remote control in a network as described in the R&S FSW User Manual.



Note that basic tasks that are also performed in the base unit in the same way are not described here. For a description of such tasks, see the R&S FSW User Manual.

In particular, this includes:

- Managing Settings and Results, i.e. storing and loading settings and result data
- Basic instrument configuration, e.g. checking the system configuration, customizing the screen layout, or configuring networks and remote operation
- Using the common status registers

The following tasks specific to MSRA mode are described here:

• Introduction	83
• Common Suffixes	88
• Activating MSRA Measurements	89
• Configuring MSRA Measurements	94
• Capturing Data and Performing Sweeps	132
• Retrieving Results	137
• Querying the Status Registers	141
• Analyzing MSRA Measurements	144
• Commands Specific to MSRA Applications	144
• Programming Example: Analyzing MSR Signals	147

11.1 Introduction

Commands are program messages that a controller (e.g. a PC) sends to the instrument or software. They operate its functions ('setting commands' or 'events') and request information ('query commands'). Some commands can only be used in one way, others work in two ways (setting and query). If not indicated otherwise, the commands can be used for settings and queries.

The syntax of a SCPI command consists of a header and, in most cases, one or more parameters. To use a command as a query, you have to append a question mark after the last header element, even if the command contains a parameter.

A header contains one or more keywords, separated by a colon. Header and parameters are separated by a "white space" (ASCII code 0 to 9, 11 to 32 decimal, e.g. blank). If there is more than one parameter for a command, these are separated by a comma from one another.

Only the most important characteristics that you need to know when working with SCPI commands are described here. For a more complete description, refer to the User Manual of the R&S FSW.



Remote command examples

Note that some remote command examples mentioned in this general introduction may not be supported by this particular application.

11.1.1 Conventions used in Descriptions

Note the following conventions used in the remote command descriptions:

- **Command usage**
If not specified otherwise, commands can be used both for setting and for querying parameters.
If a command can be used for setting or querying only, or if it initiates an event, the usage is stated explicitly.
- **Parameter usage**
If not specified otherwise, a parameter can be used to set a value and it is the result of a query.
Parameters required only for setting are indicated as **Setting parameters**.
Parameters required only to refine a query are indicated as **Query parameters**.
Parameters that are only returned as the result of a query are indicated as **Return values**.
- **Conformity**
Commands that are taken from the SCPI standard are indicated as **SCPI confirmed**. All commands used by the R&S FSW follow the SCPI syntax rules.
- **Asynchronous commands**
A command which does not automatically finish executing before the next command starts executing (overlapping command) is indicated as an **Asynchronous command**.
- **Reset values (*RST)**
Default parameter values that are used directly after resetting the instrument (*RST command) are indicated as ***RST** values, if available.
- **Default unit**
This is the unit used for numeric values if no other unit is provided with the parameter.
- **Manual operation**

If the result of a remote command can also be achieved in manual operation, a link to the description is inserted.

11.1.2 Long and Short Form

The keywords have a long and a short form. You can use either the long or the short form, but no other abbreviations of the keywords.

The short form is emphasized in upper case letters. Note however, that this emphasis only serves the purpose to distinguish the short from the long form in the manual. For the instrument, the case does not matter.

Example:

`SENSe:FREQuency:CENTer` is the same as `SENS:FREQ:CENT`.

11.1.3 Numeric Suffixes

Some keywords have a numeric suffix if the command can be applied to multiple instances of an object. In that case, the suffix selects a particular instance (e.g. a measurement window).

Numeric suffixes are indicated by angular brackets (<n>) next to the keyword.

If you don't quote a suffix for keywords that support one, a 1 is assumed.

Example:

`DISPlay[:WINDow<1...4>]:ZOOM:STATe` enables the zoom in a particular measurement window, selected by the suffix at `WINDow`.

`DISPlay:WINDow4:ZOOM:STATe ON` refers to window 4.

11.1.4 Optional Keywords

Some keywords are optional and are only part of the syntax because of SCPI compliance. You can include them in the header or not.

Note that if an optional keyword has a numeric suffix and you need to use the suffix, you have to include the optional keyword. Otherwise, the suffix of the missing keyword is assumed to be the value 1.

Optional keywords are emphasized with square brackets.

Example:

Without a numeric suffix in the optional keyword:

```
[SENSe:]FREQuency:CENTer is the same as FREQuency:CENTer
```

With a numeric suffix in the optional keyword:

```
DISPlay[:WINDow<1...4>]:ZOOM:STATe
```

DISPlay:ZOOM:STATe ON enables the zoom in window 1 (no suffix).

DISPlay:WINDow4:ZOOM:STATe ON enables the zoom in window 4.

11.1.5 Alternative Keywords

A vertical stroke indicates alternatives for a specific keyword. You can use both keywords to the same effect.

Example:

```
[SENSe:]BANDwidth|BWIDth[:RESolution]
```

In the short form without optional keywords, BAND 1MHZ would have the same effect as BWID 1MHZ.

11.1.6 SCPI Parameters

Many commands feature one or more parameters.

If a command supports more than one parameter, these are separated by a comma.

Example:

```
LAYout:ADD:WINDow Spectrum,LEFT,MTABLE
```

Parameters may have different forms of values.

- [Numeric Values](#).....86
- [Boolean](#).....87
- [Character Data](#).....88
- [Character Strings](#).....88
- [Block Data](#).....88

11.1.6.1 Numeric Values

Numeric values can be entered in any form, i.e. with sign, decimal point or exponent. In case of physical quantities, you can also add the unit. If the unit is missing, the command uses the basic unit.

Example:

with unit: SENSe:FREQuency:CENTer 1GHZ

without unit: SENSe:FREQuency:CENTer 1E9 would also set a frequency of 1 GHz.

Values exceeding the resolution of the instrument are rounded up or down.

If the number you have entered is not supported (e.g. in case of discrete steps), the command returns an error.

Instead of a number, you can also set numeric values with a text parameter in special cases.

- **MIN/MAX**
Defines the minimum or maximum numeric value that is supported.
- **DEF**
Defines the default value.
- **UP/DOWN**
Increases or decreases the numeric value by one step. The step size depends on the setting. In some cases you can customize the step size with a corresponding command.

Querying numeric values

When you query numeric values, the system returns a number. In case of physical quantities, it applies the basic unit (e.g. Hz in case of frequencies). The number of digits after the decimal point depends on the type of numeric value.

Example:

Setting: `SENSe:FREQuency:CENTer 1GHZ`

Query: `SENSe:FREQuency:CENTer?` would return `1E9`

In some cases, numeric values may be returned as text.

- **INF/NINF**
Infinity or negative infinity. Represents the numeric values `9.9E37` or `-9.9E37`.
- **NAN**
Not a number. Represents the numeric value `9.91E37`. NAN is returned in case of errors.

11.1.6.2 Boolean

Boolean parameters represent two states. The "ON" state (logically true) is represented by "ON" or a numeric value 1. The "OFF" state (logically untrue) is represented by "OFF" or the numeric value 0.

Querying boolean parameters

When you query boolean parameters, the system returns either the value 1 ("ON") or the value 0 ("OFF").

Example:

Setting: `DISPlay:WINDow:ZOOM:STATe ON`

Query: `DISPlay:WINDow:ZOOM:STATe?` would return `1`

11.1.6.3 Character Data

Character data follows the syntactic rules of keywords. You can enter text using a short or a long form. For more information see [chapter 11.1.2, "Long and Short Form"](#), on page 85.

Querying text parameters

When you query text parameters, the system returns its short form.

Example:

Setting: `SENSe:BANDwidth:RESolution:TYPE NORMal`

Query: `SENSe:BANDwidth:RESolution:TYPE?` would return `NORM`

11.1.6.4 Character Strings

Strings are alphanumeric characters. They have to be in straight quotation marks. You can use a single quotation mark (') or a double quotation mark (").

Example:

`INSTRument:DELeTe 'Spectrum'`

11.1.6.5 Block Data

Block data is a format which is suitable for the transmission of large amounts of data.

The ASCII character # introduces the data block. The next number indicates how many of the following digits describe the length of the data block. In the example the 4 following digits indicate the length to be 5168 bytes. The data bytes follow. During the transmission of these data bytes all end or other control signs are ignored until all bytes are transmitted. #0 specifies a data block of indefinite length. The use of the indefinite format requires a `NL^END` message to terminate the data block. This format is useful when the length of the transmission is not known or if speed or other considerations prevent segmentation of the data into blocks of definite length.

11.2 Common Suffixes

The following common suffixes are used in remote commands specific to MSRA mode:

Suffix	Value range	Description
<m>	1..16	Marker
<n>	1..6	Window
<t>	1..6	Trace

11.3 Activating MSRA Measurements

MSRA measurements requires a special operating mode on the R&S FSW. A measurement is started immediately with the default settings.



The special MSRA Master measurement channel is of the channel type "IQ" and is referred to by the channel name "MSRA Master". This channel cannot be replaced, deleted, or renamed.

INSTRument:CREate:DUPLicate.....	89
INSTRument:CREate[:NEW].....	89
INSTRument:CREate:REPLace.....	90
INSTRument:DELeTe.....	90
INSTRument:LIST?.....	90
INSTRument:MODE.....	91
INSTRument:REName.....	92
INSTRument[:SELect].....	92
SYSTem:PRESet:COMPAtible.....	93
SYSTem:PRESet:CHANnel[:EXECute].....	93

INSTRument:CREate:DUPLicate

This command duplicates the currently selected measurement channel, i.e starts a new measurement channel of the same type and with the identical measurement settings. The name of the new channel is the same as the copied channel, extended by a consecutive number (e.g. "Spectrum" -> "Spectrum 2").

The channel to be duplicated must be selected first using the `INST:SEL` command.

This command is not available if the MSRA Master channel is selected.

Example:

```
INST:SEL 'Spectrum'
```

```
INST:CRE:DUPL
```

Duplicates the channel named 'Spectrum' and creates a new measurement channel named 'Spectrum 2'.

Usage: Event

INSTRument:CREate[:NEW] <ChannelType>, <ChannelName>

This command adds an additional measurement channel. The number of measurement channels you can configure at the same time depends on available memory.

Parameters:

<ChannelType> Channel type of the new channel.
For a list of available channel types see `INSTRument:LIST?` on page 90.

<ChannelName> String containing the name of the channel. The channel name is displayed as the tab label for the measurement channel.
 Note: If the specified name for a new channel already exists, the default name, extended by a sequential number, is used for the new channel (see [INSTrument:LIST?](#) on page 90).

Example: `INST:CRE SAN, 'Spectrum 2'`
 Adds an additional spectrum display named "Spectrum 2".

Manual operation: See ["New Channel"](#) on page 24

INSTrument:CREate:REPLace <ChannelName1>,<ChannelType>,<ChannelName2>

This command replaces a measurement channel with another one.

Parameters:

<ChannelName1> String containing the name of the measurement channel you want to replace.

<ChannelType> Channel type of the new channel.
 For a list of available channel types see [INSTrument:LIST?](#) on page 90.

<ChannelName2> String containing the name of the new channel.
 Note: If the specified name for a new channel already exists, the default name, extended by a sequential number, is used for the new channel (see [INSTrument:LIST?](#) on page 90).

Example: `INST:CRE:REPL 'Spectrum2', IQ, 'IQAnalyzer'`
 Replaces the channel named 'Spectrum2' by a new measurement channel of type 'IQ Analyzer' named 'IQAnalyzer'.

Manual operation: See ["Replace Current Channel"](#) on page 24

INSTrument:DELeTe <ChannelName>

This command deletes a measurement channel. If you delete the last measurement channel, the default "Spectrum" channel is activated.

Parameters:

<ChannelName> String containing the name of the channel you want to delete.
 A measurement channel must exist in order to be able delete it.

Example: `INST:DEL 'Spectrum4'`
 Deletes the spectrum channel with the name 'Spectrum4'.

INSTrument:LIST?

This command queries all active measurement channels. This is useful in order to obtain the names of the existing measurement channels, which are required in order to replace or delete the channels.

Return values:

<ChannelType>
<ChannelName>

For each channel, the command returns the channel type and channel name (see tables below).

Tip: to change the channel name, use the `INSTrument:REName` command.

Example:

`INST:LIST?`

Result for 3 measurement channels:

```
'ADEM', 'Analog Demod', 'IQ', 'IQ Analyzer',
'SANALYZER', 'Spectrum'
```

Usage:

Query only

Table 11-1: Available measurement channel types and default channel names in MSRA mode

Application	<ChannelType> Parameter	Default Channel Name*)
I/Q Analyzer	IQ	IQ Analyzer
Analog Demodulation (R&S FSW-K7)	ADEM	Analog Demod
GSM (R&S FSW-K10)	GSM	GSM
VSA (R&S FSW-K70)	DDEM	VSA
3GPP FDD BTS (R&S FSW-K72)	BWCD	3G FDD BTS
TD-SCDMA BTS (R&S FSW-K76)	BTDS	TD-SCDMA BTS
cdma2000 BTS (R&S FSW-K82)	BC2K	CDMA2000 BTS
1xEV-DO BTS (R&S FSW-K84)	BDO	1xEV-DO BTS
LTE (R&S FSW-K10x)	LTE	LTE

Note: the default channel name is also listed in the table. If the specified name for a new channel already exists, the default name, extended by a sequential number, is used for the new channel.

INSTrument:MODE <OpMode>

The operating mode of the R&S FSW determines which applications are available and active. Whenever you change the operating mode, the currently active measurement channels are stored. The default operating mode is Signal and Spectrum Analyzer mode, however, the presetting can be changed.

Parameters:

<OpMode>

SANalyzer

Signal and Spectrum Analyzer mode

MSRanalyzer

Multi-Standard Radio Analysis (MSRA) mode

RTMStandard

Multi-Standard Realtime (MSRT) mode

Only available if the realtime option (R&S FSW-K160R) is installed.

*RST: SAN

Example:

INST:MODE MSR

Switches to MSRA mode.

Usage:

SCPI confirmed

INSTrument:REName <ChannelName1>, <ChannelName2>

This command renames a measurement channel.

Parameters:

<ChannelName1>

String containing the name of the channel you want to rename.

<ChannelName2>

String containing the new channel name.

Note that you can not assign an existing channel name to a new channel; this will cause an error.

Example:

INST:REN 'Spectrum2', 'Spectrum3'

Renames the channel with the name 'Spectrum2' to 'Spectrum3'.

INSTrument[:SElect] <ChannelType> | <ChannelName>

This command activates a new measurement channel with the defined channel type, or selects an existing measurement channel with the specified name.

Also see

- [INSTrument:CREate\[:NEW\]](#) on page 89

Parameters:

<ChannelType>

Channel type of the new channel.

For a list of available channel types see [INSTrument:LIST?](#) on page 90.

<ChannelName>

String containing the name of the channel.

Example:

INST SAN

Activates a measurement channel for the Spectrum application.

INST 'MySpectrum'

Selects the measurement channel named 'MySpectrum' (for example before executing further commands for that channel).

Usage:

SCPI confirmed

- Manual operation:** See ["I/Q Analyzer"](#) on page 21
 See ["Analog Demodulation"](#) on page 21
 See ["Pulse Measurements"](#) on page 21
 See ["GSM"](#) on page 21
 See ["Transient Analysis"](#) on page 22
 See ["Vector Signal Analysis \(VSA\)"](#) on page 22
 See ["3G FDD BTS"](#) on page 22
 See ["TD-SCDMA BTS"](#) on page 22
 See ["cdma2000 BTS"](#) on page 22
 See ["1xEV-DO BTS"](#) on page 23
 See ["LTE DL"](#) on page 23
 See ["New Channel"](#) on page 24

SYSTem:PRESet:COMPAtible <OpMode>

This command defines the operating mode that is activated when you switch on the R&S FSW or press the PRESET key.

For details on operating modes see [chapter 5, "Applications and Operating Modes"](#), on page 19.

Parameters:

<OpMode>

SANalyzer

(Default:) Defines Signal and Spectrum Analyzer operating mode as the presetting.

MSRA

Defines Multi-Standard Radio Analysis (MSRA) as the preset default operating mode.

RTSM

Defines Multi-Standard Realtime (MSRT) as the preset default operating mode.

*RST: SAN

Usage: Event

SYSTem:PRESet:CHANnel[:EXECute]

This command restores the default instrument settings in the current channel.

Use `INST:SEL` to select the channel.

Example:

```
INST 'Spectrum2'
```

Selects the channel for "Spectrum2".

```
SYST:PRESet:CHAN:EXEC
```

Restores the factory default settings to the "Spectrum2" channel.

Usage: Event

Manual operation: See ["Preset Channel"](#) on page 35

11.4 Configuring MSRA Measurements

- [Configuring Input/Output and Frontend Settings](#)..... 94
- [Triggering](#)..... 114
- [Configuring Data Acquisition](#)..... 122
- [Adjusting Settings Automatically](#)..... 129

11.4.1 Configuring Input/Output and Frontend Settings

The following commands are required to define input, output and frontend settings. Any settings related to data acquisition or data output are only available for the MSRA Master.

- [RF Input](#)..... 94
- [Configuring Digital I/Q Input and Output](#)..... 97
- [Configuring Input via the Analog Baseband Interface \(R&S FSW-B71\)](#)..... 100
- [Setting up Probes](#)..... 104
- [Configuring the Vertical Axis \(Amplitude, Scaling\)](#)..... 107
- [Frequency](#)..... 112
- [Configuring the Outputs](#)..... 114

11.4.1.1 RF Input

INPut:ATTenuation:PROTection:RESet	94
INPut:CONNector	94
INPut:COUPling	95
INPut:FILTer:HPASs[:STATe]	95
INPut:FILTer:YIG[:STATe]	96
INPut:IMPedance	96
INPut:SELEct	96

INPut:ATTenuation:PROTection:RESet

This command resets the attenuator and reconnects the RF input with the input mixer after an overload condition occurred and the protection mechanism intervened. The error status bit (bit 3 in the `STAT:QUES:POW` status register) and the `INPUT OVLD` message in the status bar are cleared.

The command works only if the overload condition has been eliminated first.

Usage: Event

INPut:CONNector <ConnType>

Determines whether the RF input data is taken from the RF input connector or the optional Analog Baseband I connector. This command is only available if the Analog Baseband interface (R&S FSW-B71) is installed and active for input.

For more information on the Analog Baseband Interface (R&S FSW-B71) see the R&S FSW I/Q Analyzer and I/Q Input User Manual.

Parameters:

<ConnType> **RF**
RF input connector

AIQI
Analog Baseband I connector

*RST: RF

Example:

INP:CONN:AIQI
Selects the analog baseband input.

Usage:

SCPI confirmed

Manual operation: See "[Input Connector](#)" on page 37

INPut:COUPling <CouplingType>

This command selects the coupling type of the RF input.

Parameters:

<CouplingType> **AC**
AC coupling

DC
DC coupling

*RST: AC

Example:

INP:COUP DC

Usage:

SCPI confirmed

Manual operation: See "[Input Coupling](#)" on page 36

INPut:FILTer:HPASs[:STATe] <State>

Activates an additional internal high-pass filter for RF input signals from 1 GHz to 3 GHz. This filter is used to remove the harmonics of the R&S FSW in order to measure the harmonics for a DUT, for example.

This function requires option R&S FSW-B13.

(Note: for RF input signals outside the specified range, the high-pass filter has no effect. For signals with a frequency of approximately 4 GHz upwards, the harmonics are suppressed sufficiently by the YIG filter.)

Parameters:

<State> ON | OFF

*RST: OFF

Usage:

SCPI confirmed

Manual operation: See "[High-Pass Filter 1...3 GHz](#)" on page 37

INPut:FILTer:YIG[:STATe] <State>

This command turns the YIG-preselector on and off.

Note the special conditions and restrictions for the YIG filter described in "[YIG-Preselector](#)" on page 37.

Parameters:

<State> ON | OFF | 0 | 1
 *RST: 1 (0 for I/Q Analyzer, GSM, VSA and MC Group Delay measurements)

Example:

INP:FILT:YIG OFF
 Deactivates the YIG-preselector.

Manual operation: See "[YIG-Preselector](#)" on page 37

INPut:IMPedance <Impedance>

This command selects the nominal input impedance of the RF input.

75 Ω should be selected if the 50 Ω input impedance is transformed to a higher impedance using a matching pad of the RAZ type (= 25 Ω in series to the input impedance of the instrument). The power loss correction value in this case is 1.76 dB = 10 log (75 Ω /50 Ω).

Parameters:

<Impedance> 50 | 75
 *RST: 50 Ω

Example:

INP:IMP 75

Usage:

SCPI confirmed

Manual operation: See "[Impedance](#)" on page 37

INPut:SElect <Source>

This command selects the signal source for measurements, i.e. it defines which connector is used to input data to the R&S FSW. If no additional options are installed, only RF input is supported.

Parameters:

<Source> **RF**
 Radio Frequency ("RF INPUT" connector)
 *RST: RF

Manual operation: See "[Digital I/Q Input State](#)" on page 38
 See "[Analog Baseband Input State](#)" on page 40

11.4.1.2 Configuring Digital I/Q Input and Output

Useful commands for digital I/Q data described elsewhere:

- `INP:SEL DIQ` (see `INPut:SElect` on page 96)
- `TRIGger[:SEquence]:LEVel:BBPower` on page 116



Remote commands for the R&S DigIConf software

Remote commands for the R&S DigIConf software always begin with `SOURce:EBOX`. Such commands are passed on from the R&S FSW to the R&S DigIConf automatically which then configures the R&S EX-IQ-BOX via the USB connection.

All remote commands available for configuration via the R&S DigIConf software are described in the "R&S®EX-IQ-BOX Digital Interface Module R&S®DigIConf Software Operating Manual".

Example 1:

```
SOURce:EBOX:*RST
SOURce:EBOX:*IDN?
```

Result:

```
"Rohde&Schwarz,DigIConf,02.05.436 Build 47"
```

Example 2:

```
SOURce:EBOX:USER:CLOCK:REFerence:FREQuency 5MHZ
```

Defines the frequency value of the reference clock.

Remote commands exclusive to digital I/Q data input and output

<code>INPut:DIQ:CDEvice</code>	97
<code>INPut:DIQ:RANGe[:UPPer]:AUTO</code>	98
<code>INPut:DIQ:RANGe:COUPling</code>	99
<code>INPut:DIQ:RANGe[:UPPer]</code>	99
<code>INPut:DIQ:RANGe[:UPPer]:UNIT</code>	99
<code>INPut:DIQ:SRATe</code>	100
<code>INPut:DIQ:SRATe:AUTO</code>	100

`INPut:DIQ:CDEvice`

This command queries the current configuration and the status of the digital I/Q input from the optional Digital Baseband Interface (R&S FSW-B17).

For details see the section "Interface Status Information" for the Digital Baseband Interface (R&S FSW-B17) in the R&S FSW I/Q Analyzer User Manual.

Return values:

<code><ConnState></code>	Defines whether a device is connected or not.
0	No device is connected.
1	A device is connected.

<DeviceName>	Device ID of the connected device
<SerialNumber>	Serial number of the connected device
<PortName>	Port name used by the connected device
<SampleRate>	Maximum or currently used sample rate of the connected device in Hz (depends on the used connection protocol version; indicated by <SampleRateType> parameter)
<MaxTransferRate>	Maximum data transfer rate of the connected device in Hz
<ConnProtState>	State of the connection protocol which is used to identify the connected device. Not Started Has to be Started Started Passed Failed Done
<PRBSTestState>	State of the PRBS test. Not Started Has to be Started Started Passed Failed Done
<SampleRateType>	0 Maximum sample rate is displayed 1 Current sample rate is displayed
<FullScaleLevel>	The level (in dBm) that should correspond to an I/Q sample with the magnitude "1" (if transferred from connected device); If not available, $9.97e37$ is returned

Example: INP:DIQ:CDEV?
Result:
1, SMU200A, 103634, Out
A, 70000000, 100000000, Passed, Not Started, 0, 0

Manual operation: See "[Connected Instrument](#)" on page 39

INPut:DIQ:RANGe[:UPPer]:AUTO <State>

If enabled, the digital input full scale level is automatically set to the value provided by the connected device (if available).

This command is only available if the optional Digital Baseband interface (option R&S FSW-B17) is installed.

Parameters:

<State> ON | OFF
 *RST: OFF

Manual operation: See "[Full Scale Level](#)" on page 39

INPut:DIQ:RANGe:COUPling <State>

If enabled, the reference level for digital input is adjusted to the full scale level automatically if the full scale level changes.

This command is only available if the optional Digital Baseband Interface (R&S FSW-B17) is installed.

Parameters:

<State> ON | OFF
 *RST: OFF

Manual operation: See "[Adjust Reference Level to Full Scale Level](#)" on page 39

INPut:DIQ:RANGe[:UPPer] <Level>

Defines or queries the "Full Scale Level", i.e. the level that corresponds to an I/Q sample with the magnitude "1".

This command is only available if the optional Digital Baseband Interface (R&S FSW-B17) is installed.

Parameters:

<Level> <numeric value>
 Range: 1 μ V to 7.071 V
 *RST: 1 V

Manual operation: See "[Full Scale Level](#)" on page 39

INPut:DIQ:RANGe[:UPPer]:UNIT <Unit>

Defines the unit of the full scale level (see "[Full Scale Level](#)" on page 39). The availability of units depends on the measurement application you are using.

This command is only available if the optional Digital Baseband Interface (R&S FSW-B17) is installed.

Parameters:

<Level> VOLT | DBM | DBPW | WATT | DBMV | DBUV | DBUA | AMPere
 *RST: Volt

Manual operation: See "[Full Scale Level](#)" on page 39

INPut:DIQ:SRATe <SampleRate>

This command specifies or queries the sample rate of the input signal from the Digital Baseband Interface (R&S FSW-B17, see ["Input Sample Rate"](#) on page 38).

Parameters:

<SampleRate> Range: 1 Hz to 10 GHz
 *RST: 32 MHz

Example: INP:DIQ:SRAT 200 MHz

Manual operation: See ["Input Sample Rate"](#) on page 38

INPut:DIQ:SRATe:AUTO <State>

If enabled, the sample rate of the digital I/Q input signal is set automatically by the connected device.

This command is only available if the optional Digital Baseband Interface (R&S FSW-B17) is installed.

Parameters:

<State> ON | OFF
 *RST: OFF

Manual operation: See ["Input Sample Rate"](#) on page 38

11.4.1.3 Configuring Input via the Analog Baseband Interface (R&S FSW-B71)

The following commands are required to control the Analog Baseband Interface (R&S FSW-B71) in a remote environment. They are only available if this option is installed.

For more information on the Analog Baseband Interface see the R&S FSW I/Q Analyzer User Manual.

Useful commands for Analog Baseband data described elsewhere:

- INP:SEL AIQ (see [INPut:SElect](#) on page 96)
- [SENSe:]FREQuency:CENTer on page 112

Commands for the Analog Baseband calibration signal are described in the R&S FSW User Manual.

Remote commands exclusive to Analog Baseband data input and output

INPut:IQ:BALanced[:STATe]	101
INPut:IQ:FULLscale:AUTO	101
INPut:IQ:FULLscale[:LEVel]	101
INPut:IQ:TYPE	102
CALibration:AIQ:DCOFfset:I	102
CALibration:AIQ:DCOFfset:Q	102
[SENSe:]PROBe<ch>:SETup:CMOFfset	103
TRACe:IQ:APCon[:STATe]	103

TRACe:IQ:APCon:A.....	104
TRACe:IQ:APCon:B.....	104
TRACe:IQ:APCon:REsult?.....	104

INPut:IQ:BALanced[:STATe] <State>

This command defines whether the input is provided as a differential signal via all 4 Analog Baseband connectors or as a plain I/Q signal via 2 simple-ended lines.

Parameters:

<State> **ON**
 Differential
 OFF
 Simple-ended
 *RST: ON

Example: INP:IQ:BAL OFF

Manual operation: See "[Input configuration](#)" on page 41

INPut:IQ:FULLscale:AUTO <State>

This command defines whether the full scale level (i.e. the maximum input power on the Baseband Input connector) is defined automatically according to the reference level, or manually.

Parameters:

<State> **ON**
 Automatic definition
 OFF
 Manual definition according to [INPut:IQ:FULLscale\[:LEVel\]](#) on page 101
 *RST: ON

Example: INP:IQ:FULL:AUTO OFF

Manual operation: See "[Full Scale Level Mode / Value](#)" on page 47

INPut:IQ:FULLscale[:LEVel] <PeakVoltage>

This command defines the peak voltage at the Baseband Input connector if the full scale level is set to manual mode (see [INPut:IQ:FULLscale:AUTO](#) on page 101).

Parameters:

<PeakVoltage> 0.25 V | 0.5 V | 1 V | 2 V
 Peak voltage level at the connector.
 For probes, the possible full scale values are adapted according to the probe's attenuation and maximum allowed power.
 *RST: 1V

Example: INP:IQ:FULL 0.5V

Manual operation: See "[Full Scale Level Mode / Value](#)" on page 47

INPut:IQ:TYPE <DataType>

This command defines the format of the input signal.

Parameters:

<DataType>

IQ | I | Q

IQ

The input signal is filtered and resampled to the sample rate of the application.

Two input channels are required for each input signal, one for the in-phase component, and one for the quadrature component.

I

The in-phase component of the input signal is filtered and resampled to the sample rate of the application. If the center frequency is not 0 (see [[SENSe:\]FREQuency:CENTer](#) on page 112), the in-phase component of the input signal is down-converted first (Low IF I).

Q

The quadrature component of the input signal is filtered and resampled to the sample rate of the application. If the center frequency is not 0, the quadrature component of the input signal is down-converted first (Low IF Q).

*RST: IQ

Example: INP:IQ:TYPE Q

Manual operation: See "[I/Q Mode](#)" on page 41

CALibration:AIQ:DCOffset:I <Offset>

This command defines a DC offset of the I input from the Analog Baseband interface (R&S FSW-B71).

Parameters:

<Offset>

numeric value

DC offset

*RST: 0

Default unit: V

Example: CAL:AIQ:DCOF:I 0.001

CALibration:AIQ:DCOffset:Q <Offset>

This command defines a DC offset of the Q input from the Analog Baseband interface (R&S FSW-B71).

Parameters:

<Offset> numeric value
 DC offset
 *RST: 0
 Default unit: V

Example: CAL:AIQ:DCOF:Q 0.001

[SENSe:]PROBe<ch>:SETup:CMOffset <CMOffset>

Sets the common mode offset. The setting is only available if a differential probe is connected to the R&S FSW.

If the probe is disconnected, the common mode offset of the probe is reset to 0.0 V.

For details see the R&S FSW I/Q Analyzer and I/Q Input User Manual.

Suffix:

<ch> 1..4
 Selects the input channel.

Parameters:

<CMOffset> Range: -100E+24 to 100E+24
 Increment: 1E-3
 *RST: 0
 Default unit: V

TRACe:IQ:APCon[:STATe] <State>

If enabled, the average power consumption is calculated at the end of the I/Q data measurement. This command must be set *before* the measurement is performed!

The conversion factors A and B for the calculation are defined using [TRACe:IQ:APCon:A](#) and [TRACe:IQ:APCon:B](#).

The results can be queried using [TRACe:IQ:APCon:RESult?](#) on page 104.

For details see the R&S FSW I/Q Analyzer and I/Q Input User Manual.

Parameters:

<State> ON | OFF
 *RST: OFF

Example:

```
*RST
TRAC:IQ:STAT ON
TRAC:IQ:SRAT 1MHZ
TRAC:IQ:RLEN 1000000
TRAC:IQ:APC:STAT ON
TRAC:IQ:APC:A 3.0
TRAC:IQ:APC:B 0.6
INIT;*WAI
TRAC:IQ:APC:RES?
```

TRACe:IQ:APCon:A <ConvFact>

Defines the conversion factor A for the calculation of the average power consumption.

For details see the R&S FSW I/Q Analyzer and I/Q Input User Manual.

Parameters:

<ConvFact> numeric value
*RST: 1.0

TRACe:IQ:APCon:B <ConvFact>

Defines the conversion factor B for the calculation of the average power consumption.

For details see the R&S FSW I/Q Analyzer and I/Q Input User Manual.

Parameters:

<ConvFact> numeric value
*RST: 0.0

TRACe:IQ:APCon:RESult?

Queries the average power consumption for an analog baseband input. This value is only calculated at the end of the I/Q data measurement if the [TRACe:IQ:APCon\[:STATe\]](#) command is set to ON *before* the measurement is performed!

For details see the R&S FSW I/Q Analyzer and I/Q Input User Manual.

Parameters:

<Average> numeric value
Default unit: W

Usage: Query only

11.4.1.4 Setting up Probes

Probes can be connected to the optional BASEBAND INPUT connectors, if the Analog Baseband interface (option R&S FSW-B71) is installed.

[SENSe:]PROBe<p>:ID:PARTnumber?	104
[SENSe:]PROBe<p>:ID:SRNumber?	105
[SENSe:]PROBe<p>:SETup:MODE	105
[SENSe:]PROBe<p>:SETup:NAME?	106
[SENSe:]PROBe<p>:SETup:STATe?	106
[SENSe:]PROBe<p>:SETup:TYPE?	106

[SENSe:]PROBe<p>:ID:PARTnumber?

Queries the R&S part number of the probe.

Suffix:

<p>

1 | 2 | 3

Selects the connector:

1 = Baseband Input I

2 = Baseband Input Q

3 = RF (currently not supported; use "1" with RF Input Connector setting "Baseband Input I")

Return values:

<PartNumber>

Part number in a string.

Usage:

Query only

[SENSe:]PROBe<p>:ID:SRNumber?

Queries the serial number of the probe.

Suffix:

<p>

1 | 2 | 3

Selects the connector:

1 = Baseband Input I

2 = Baseband Input Q

3 = RF (currently not supported; use "1" with RF Input Connector setting "Baseband Input I")

Return values:

<SerialNo>

Serial number in a string.

Usage:

Query only

[SENSe:]PROBe<p>:SETup:MODE <Mode>

Select the action that is started with the micro button on the probe head.

See also: "[Microbutton Action](#)" on page 42.**Suffix:**

<p>

1 | 2 | 3

Selects the connector:

1 = Baseband Input I

2 = Baseband Input Q

3 = RF (currently not supported; use "1" with RF Input Connector setting "Baseband Input I")

Parameters:

<Mode>

RSINgle

Run single: starts one data acquisition.

NOAction

Nothing is started on pressing the micro button.

*RST: RSINgle

Manual operation: See "[Microbutton Action](#)" on page 42

[SENSe:]PROBe<p>:SETup:NAME?

Queries the name of the probe.

Suffix:

<p> 1 | 2 | 3
 Selects the connector:
 1 = Baseband Input I
 2 = Baseband Input Q
 3 = RF (currently not supported; use "1" with RF Input Connector setting "Baseband Input I")

Return values:

<Name> Name string

Usage: Query only

[SENSe:]PROBe<p>:SETup:STATe?

Queries if the probe at the specified connector is active (detected) or not active (not detected). To switch the probe on, i.e. activate input from the connector, use `INP:SEL:AIQ` (see `INPut:SElect` on page 96).

Suffix:

<p> 1 | 2 | 3
 Selects the connector:
 1 = Baseband Input I
 2 = Baseband Input Q
 3 = RF (currently not supported; use "1" with RF Input Connector setting "Baseband Input I")

Return values:

<State> DETected | NDETECTED
 *RST: NDETECTED

Usage: Query only

[SENSe:]PROBe<p>:SETup:TYPE?

Queries the type of the probe.

Suffix:

<p> 1 | 2 | 3
 Selects the connector:
 1 = Baseband Input I
 2 = Baseband Input Q
 3 = RF (currently not supported; use "1" with RF Input Connector setting "Baseband Input I")

Return values:

<Type> String containing one of the following values:

- None (no probe detected)
- active differential
- active single-ended

Usage: Query only

11.4.1.5 Configuring the Vertical Axis (Amplitude, Scaling)

The following commands are required to configure the amplitude and vertical axis settings in a remote environment.

- [Amplitude Settings](#)..... 107
- [Configuring the Attenuation](#).....108
- [Configuring a Preamplifier](#).....109
- [Scaling the Y-Axis](#)..... 110

Amplitude Settings

Useful commands for amplitude configuration described elsewhere:

- [\[SENSe:\]ADJust:LEVel](#) on page 132

Remote commands exclusive to amplitude configuration:

- [CALCulate<n>:MARKer<m>:FUNCtion:REFerence](#)..... 107
- [DISPlay\[:WINDow<n>\]:TRACe:Y\[:SCALe\]:RLEVel](#)..... 107
- [DISPlay\[:WINDow<n>\]:TRACe:Y\[:SCALe\]:RLEVel:OFFSet](#)..... 108

CALCulate<n>:MARKer<m>:FUNCtion:REFerence

This command matches the reference level to the power level of a marker.

If you use the command in combination with a delta marker, that delta marker is turned into a normal marker.

Example: `CALC:MARK2:FUNC:REF`
Sets the reference level to the level of marker 2.

Usage: Event

DISPlay[:WINDow<n>]:TRACe:Y[:SCALe]:RLEVel <ReferenceLevel>

This command defines the reference level.

Example: `DISP:TRAC:Y:RLEV -60dBm`

Usage: SCPI confirmed

Manual operation: See "[Reference Level](#)" on page 44

DISPlay[:WINDow<n>]:TRACe:Y[:SCALe]:RLEVel:OFFSet <Offset>

This command defines a reference level offset.

Parameters:

<Offset> Range: -200 dB to 200 dB
 *RST: 0dB

Example: DISP:TRAC:Y:RLEV:OFFS -10dB

Manual operation: See "[Shifting the Display \(Offset\)](#)" on page 44

Configuring the Attenuation

INPut:ATTenuation.....	108
INPut:ATTenuation:AUTO.....	108
INPut:EATT.....	109
INPut:EATT:AUTO.....	109
INPut:EATT:STATE.....	109

INPut:ATTenuation <Attenuation>

This command defines the total attenuation for RF input.

If you set the attenuation manually, it is no longer coupled to the reference level, but the reference level is coupled to the attenuation. Thus, if the current reference level is not compatible with an attenuation that has been set manually, the command also adjusts the reference level.

Parameters:

<Attenuation> Range: see data sheet
 Increment: 5 dB
 *RST: 10 dB (AUTO is set to ON)

Example: INP:ATT 30dB
 Defines a 30 dB attenuation and decouples the attenuation from the reference level.

Usage: SCPI confirmed

Manual operation: See "[Attenuation Mode / Value](#)" on page 44

INPut:ATTenuation:AUTO <State>

This command couples or decouples the attenuation to the reference level. Thus, when the reference level is changed, the R&S FSW determines the signal level for optimal internal data processing and sets the required attenuation accordingly.

Parameters:

<State> ON | OFF | 0 | 1
 *RST: 1

Example: INP:ATT:AUTO ON
 Couples the attenuation to the reference level.

Usage: SCPI confirmed

Manual operation: See "[Attenuation Mode / Value](#)" on page 44

INPut:EATT <Attenuation>

This command defines an electronic attenuation manually. Automatic mode must be switched off (`INP:EATT:AUTO OFF`, see `INPut:EATT:AUTO` on page 109).

If the current reference level is not compatible with an attenuation that has been set manually, the command also adjusts the reference level.

Parameters:

<Attenuation> attenuation in dB
 Range: see data sheet
 Increment: 1 dB
 *RST: 0 dB (OFF)

Example: `INP:EATT:AUTO OFF`
 `INP:EATT 10 dB`

Manual operation: See "[Using Electronic Attenuation \(Option B25\)](#)" on page 45

INPut:EATT:AUTO <State>

This command turns automatic selection of the electronic attenuation on and off.

If on, electronic attenuation reduces the mechanical attenuation whenever possible.

Parameters:

<State> ON | OFF | 0 | 1
 *RST: 1

Example: `INP:EATT:AUTO OFF`

Manual operation: See "[Using Electronic Attenuation \(Option B25\)](#)" on page 45

INPut:EATT:STATe <State>

This command turns the electronic attenuator on and off.

Parameters:

<State> ON | OFF
 *RST: OFF

Example: `INP:EATT:STAT ON`
 Switches the electronic attenuator into the signal path.

Manual operation: See "[Using Electronic Attenuation \(Option B25\)](#)" on page 45

Configuring a Preamplifier

`INPut:GAIN:STATe`..... 110
`INPut:GAIN[:VALue]`..... 110

INPut:GAIN:STATe <State>

This command turns the preamplifier on and off.

The command requires option R&S FSW-B24.

Parameters:

<State> ON | OFF
*RST: OFF

Example: INP:GAIN:STAT ON
Switches on 30 dB preamplification.

Usage: SCPI confirmed

Manual operation: See "[Preamplifier \(option B24\)](#)" on page 45

INPut:GAIN[:VALue] <Gain>

This command selects the preamplification level if the preamplifier is activated (INP:GAIN:STAT ON, see [INPut:GAIN:STATe](#) on page 110).

The command requires option R&S FSW-B24.

Parameters:

<Gain> 15 dB | 30 dB
The availability of preamplification levels depends on the R&S FSW model.
R&S FSW8/13: 15dB and 30 dB
R&S FSW26 or higher: 30 dB
All other values are rounded to the nearest of these two.
*RST: OFF

Example: INP:GAIN:VAL 30
Switches on 30 dB preamplification.

Usage: SCPI confirmed

Manual operation: See "[Preamplifier \(option B24\)](#)" on page 45

Scaling the Y-Axis

DISPlay[:WINDow<n>]:TRACe:Y[:SCALe]	110
DISPlay[:WINDow<n>]:TRACe:Y[:SCALe]:AUTO ONCE	111
DISPlay[:WINDow<n>]:TRACe:Y[:SCALe]:MODE	111
DISPlay[:WINDow<n>]:TRACe:Y[:SCALe]:RPOSition	111
DISPlay[:WINDow<n>]:TRACe:Y:SPACing	111

DISPlay[:WINDow<n>]:TRACe:Y[:SCALe] <Range>

This command defines the display range of the y-axis.

Example: DISP:TRAC:Y 110dB

Usage: SCPI confirmed

Manual operation: See "[Range](#)" on page 48
See "[Y-Axis Max](#)" on page 49

DISPlay[:WINDow<n>]:TRACe:Y[:SCALE]:AUTO ONCE

Automatic scaling of the y-axis is performed once, then switched off again.

Usage: SCPI confirmed

DISPlay[:WINDow<n>]:TRACe:Y[:SCALE]:MODE <Mode>

This command selects the type of scaling of the y-axis.

When the display update during remote control is off, this command has no immediate effect.

Parameters:

<Mode>	ABSolute absolute scaling of the y-axis
	RELative relative scaling of the y-axis
*RST:	ABSolute

Example: `DISP:TRAC:Y:MODE REL`

Manual operation: See "[Scaling](#)" on page 48

DISPlay[:WINDow<n>]:TRACe:Y[:SCALE]:RPOSition <Position>

This command defines the vertical position of the reference level on the display grid.

The R&S FSW adjusts the scaling of the y-axis accordingly.

Example: `DISP:TRAC:Y:RPOS 50PCT`

Usage: SCPI confirmed

Manual operation: See "[Ref Level Position](#)" on page 48

DISPlay[:WINDow<n>]:TRACe:Y:SPACing <ScalingType>

This command selects the scaling of the y-axis.

Parameters:	
<ScalingType>	<p>LOGarithmic Logarithmic scaling.</p> <p>LINear Linear scaling in %.</p> <p>LDB Linear scaling in the specified unit.</p> <p>PERCent Linear scaling in %.</p> <p>*RST: LOGarithmic</p>
Example:	<pre>DISP:TRAC:Y:SPAC LIN</pre> <p>Selects linear scaling in %.</p>
Usage:	SCPI confirmed
Manual operation:	See "Scaling" on page 48

11.4.1.6 Frequency

[SENSe:]FREQUENCY:CENTer.....	112
[SENSe:]FREQUENCY:CENTer:STEP.....	113
[SENSe:]FREQUENCY:CENTer:STEP:AUTO.....	113
[SENSe:]FREQUENCY:OFFSet.....	113

[SENSe:]FREQUENCY:CENTer <Frequency>

This command defines the center frequency.

Parameters:	
<Frequency>	<p>The allowed range and f_{\max} is specified in the data sheet.</p> <p>UP Increases the center frequency by the step defined using the [SENSe:]FREQUENCY:CENTer:STEP command.</p> <p>DOWN Decreases the center frequency by the step defined using the [SENSe:]FREQUENCY:CENTer:STEP command.</p> <p>*RST: $f_{\max}/2$ Default unit: Hz</p>
Example:	<pre>FREQ:CENT 100 MHz FREQ:CENT:STEP 10 MHz FREQ:CENT UP</pre> <p>Sets the center frequency to 110 MHz.</p>
Usage:	SCPI confirmed
Manual operation:	<p>See "Center Frequency" on page 41</p> <p>See "Center frequency" on page 50</p>

[SENSe:]FREQUENCY:CENTer:STEP <StepSize>

This command defines the center frequency step size.

You can increase or decrease the center frequency quickly in fixed steps using the `SENS:FREQ UP AND SENS:FREQ DOWN` commands, see [\[SENSe:\]FREQUENCY:CENTer](#) on page 112.

Parameters:

<StepSize> f_{\max} is specified in the data sheet.
 Range: 1 to fMAX
 *RST: 0.1 x span
 Default unit: Hz

Example:

```
FREQ:CENT 100 MHz
FREQ:CENT:STEP 10 MHz
FREQ:CENT UP
Sets the center frequency to 110 MHz.
```

Manual operation: See ["Center Frequency Stepsize"](#) on page 50

[SENSe:]FREQUENCY:CENTer:STEP:AUTO <State>

This command couples or decouples the center frequency step size to the span.

Parameters:

<State> ON | OFF | 0 | 1
 *RST: 1

Example:

```
FREQ:CENT:STEP:AUTO ON
Activates the coupling of the step size to the span.
```

[SENSe:]FREQUENCY:OFFSet <Offset>

This command defines a frequency offset.

If this value is not 0 Hz, the application assumes that the input signal was frequency shifted outside the application. All results of type "frequency" will be corrected for this shift numerically by the application.

See also ["Frequency Offset"](#) on page 50.

Note: In MSRA mode, the setting command is only available for the MSRA Master. For MSRA applications, only the query command is available.

Parameters:

<Offset> Range: -100 GHz to 100 GHz
 *RST: 0 Hz

Example:

```
FREQ:OFFS 1GHZ
```

Usage: SCPI confirmed

Manual operation: See ["Frequency Offset"](#) on page 50

11.4.1.7 Configuring the Outputs



Configuring trigger input/output is described in [chapter 11.4.2.2, "Configuring the Trigger Output"](#), on page 120.

DIAGnostic:SERvice:NSOource.....	114
OUTPut:IF:IFFrequency.....	114

DIAGnostic:SERvice:NSOource <State>

This command turns the 28 V supply of the BNC connector labeled NOISE SOURCE CONTROL on the front panel on and off.

Parameters:

<State> ON | OFF
 *RST: OFF

Example: DIAG:SERV:NSO ON

Manual operation: See "[Noise Source](#)" on page 65

OUTPut:IF:IFFrequency <Frequency>

This command defines the frequency for the IF output. The IF frequency of the signal is converted accordingly.

This command is available in the time domain and if the IF/VIDEO/DEMODO output is configured for IF.

Parameters:

<Frequency> *RST: 50.0 MHz

11.4.2 Triggering

The following remote commands are required to configure a triggered measurement in a remote environment. These commands are only available for the MSRA Master channel. More details are described for manual operation in [chapter 7.6, "Trigger Settings"](#), on page 51.



*OPC should be used after requesting data. This will hold off any subsequent changes to the selected trigger source, until after the sweep is completed and the data is returned.

- [Configuring the Triggering Conditions](#)..... 115
- [Configuring the Trigger Output](#)..... 120

11.4.2.1 Configuring the Triggering Conditions

TRIGger[:SEQuence]:BBPower:HOLDoff.....	115
TRIGger[:SEQuence]:DTIME.....	115
TRIGger[:SEQuence]:HOLDoff[:TIME].....	116
TRIGger[:SEQuence]:IFPower:HOLDoff.....	116
TRIGger[:SEQuence]:IFPower:HYSTeresis.....	116
TRIGger[:SEQuence]:LEVel:BBPower.....	116
TRIGger[:SEQuence]:LEVel[:EXTErnal<port>].....	117
TRIGger[:SEQuence]:LEVel:IFPower.....	117
TRIGger[:SEQuence]:LEVel:IQPower.....	117
TRIGger[:SEQuence]:LEVel:RFPower.....	118
TRIGger[:SEQuence]:SLOPe.....	118
TRIGger[:SEQuence]:SOURce.....	118
TRIGger[:SEQuence]:TIME:RINTerval.....	120

TRIGger[:SEQuence]:BBPower:HOLDoff <Period>

This command defines the holding time before the baseband power trigger event.

The command requires the **Digital Baseband Interface (R&S FSW-B17)** or the **Analog Baseband Interface (R&S FSW-B71)**.

Note that this command is maintained for compatibility reasons only. Use the `TRIGger[:SEQuence]:IFPower:HOLDoff` on page 116 command for new remote control programs.

Parameters:

<Period> Range: 150 ns to 1000 s
 *RST: 150 ns

Example:

```
TRIG:SOUR BBP
Sets the baseband power trigger source.
TRIG:BBP:HOLD 200 ns
Sets the holding time to 200 ns.
```

TRIGger[:SEQuence]:DTIME <DropoutTime>

Defines the time the input signal must stay below the trigger level before a trigger is detected again.

For input from the Analog Baseband Interface (R&S FSW-B71) using the baseband power trigger (BBP), the default drop out time is set to 100 ns to avoid unintentional trigger events (as no hysteresis can be configured in this case).

Parameters:

<DropoutTime> Dropout time of the trigger.
 Range: 0 s to 10.0 s
 *RST: 0 s

Manual operation: See "Drop-Out Time" on page 55

TRIGger[:SEQuence]:HOLDoff[:TIME] <Offset>

Defines the time offset between the trigger event and the start of the sweep (data capturing).

Parameters:

<Offset> *RST: 0 s

Example: TRIG:HOLD 500us

Manual operation: See "[Trigger Offset](#)" on page 55

TRIGger[:SEQuence]:IFPower:HOLDoff <Period>

This command defines the holding time before the next trigger event.

Note that this command can be used for **any trigger source**, not just IF Power (despite the legacy keyword).

Parameters:

<Period> Range: 0 s to 10 s
*RST: 0 s

Example: TRIG:SOUR EXT
Sets an external trigger source.
TRIG:IFP:HOLD 200 ns
Sets the holding time to 200 ns.

Manual operation: See "[Trigger Holdoff](#)" on page 56

TRIGger[:SEQuence]:IFPower:HYSTeresis <Hysteresis>

This command defines the trigger hysteresis, which is only available for "IF Power" trigger sources.

Parameters:

<Hysteresis> Range: 3 dB to 50 dB
*RST: 3 dB

Example: TRIG:SOUR IFP
Sets the IF power trigger source.
TRIG:IFP:HYST 10DB
Sets the hysteresis limit value.

Manual operation: See "[Hysteresis](#)" on page 56

TRIGger[:SEQuence]:LEVel:BBPower <Level>

This command sets the level of the baseband power trigger.

This command is available for the **Digital Baseband Interface (R&S FSW-B17)** and the **Analog Baseband Interface (R&S FSW-B71)**.

Parameters:

<Level> Range: -50 dBm to +20 dBm
 *RST: -20 dBm

Example: TRIG:LEV:BB -30DBM

TRIGger[:SEQuence]:LEVel[:EXTeRnal<port>] <TriggerLevel>

This command defines the level the external signal must exceed to cause a trigger event.

Suffix:

<port> Selects the trigger port.
 1 = trigger port 1 (TRIGGER INPUT connector on front panel)
 2 = trigger port 2 (TRIGGER INPUT/OUTPUT connector on front panel)
 3 = trigger port 3 (TRIGGER3 INPUT/OUTPUT connector on rear panel)

Parameters:

<TriggerLevel> Range: 0.5 V to 3.5 V
 *RST: 1.4 V

Example: TRIG:LEV 2V

Manual operation: See "[Trigger Level](#)" on page 55

TRIGger[:SEQuence]:LEVel:IFPower <TriggerLevel>

This command defines the power level at the third intermediate frequency that must be exceeded to cause a trigger event. Note that any RF attenuation or preamplification is considered when the trigger level is analyzed. If defined, a reference level offset is also considered.

Parameters:

<TriggerLevel> For details on available trigger levels and trigger bandwidths see the data sheet.
 *RST: -10 dBm

Example: TRIG:LEV:IFP -30DBM

TRIGger[:SEQuence]:LEVel:IQPower <TriggerLevel>

This command defines the magnitude the I/Q data must exceed to cause a trigger event. Note that any RF attenuation or preamplification is considered when the trigger level is analyzed.

Parameters:

<TriggerLevel> Range: -130 dBm to 30 dBm
 *RST: -20 dBm

Example: TRIG:LEV:IQP -30DBM

TRIGger[:SEQuence]:LEVel:RFPower <TriggerLevel>

This command defines the power level the RF input must exceed to cause a trigger event. Note that any RF attenuation or preamplification is considered when the trigger level is analyzed. If defined, a reference level offset is also considered.

The input signal must be between 500 MHz and 8 GHz.

Parameters:

<TriggerLevel> For details on available trigger levels and trigger bandwidths see the data sheet.

*RST: -20 dBm

Example: TRIG:LEV:RFP -30dBm

TRIGger[:SEQuence]:SLOPe <Type>

For external and time domain trigger sources you can define whether triggering occurs when the signal rises to the trigger level or falls down to it.

Parameters:

<Type> POSitive | NEGative

POSitive

Triggers when the signal rises to the trigger level (rising edge).

NEGative

Triggers when the signal drops to the trigger level (falling edge).

*RST: POSitive

Example: TRIG:SLOP NEG

Manual operation: See "[Slope](#)" on page 56

TRIGger[:SEQuence]:SOURce <Source>

This command selects the trigger source.

Note on external triggers:

If a measurement is configured to wait for an external trigger signal in a remote control program, remote control is blocked until the trigger is received and the program can continue. Make sure this situation is avoided in your remote control programs.

Parameters:

<Source>

IMMediate

Free Run

EXTernal

Trigger signal from the TRIGGER INPUT connector.

EXT2

Trigger signal from the TRIGGER INPUT/OUTPUT connector.

Note: Connector must be configured for "Input".

EXT3

Trigger signal from the TRIGGER 3 INPUT/ OUTPUT connector.

Note: Connector must be configured for "Input".

RFPower

First intermediate frequency

IFPower

Second intermediate frequency

IQPower

Magnitude of sampled I/Q data

For applications that process I/Q data, such as the I/Q Analyzer or optional applications.

BBPower

Baseband power (for digital input via the Digital Baseband Interface R&S FSW-B17)

Baseband power (for digital input via the Digital Baseband Interface R&S FSW-B17 or the Analog Baseband interface R&S FSW-B71)

PSEN

External power sensor

GP0 | GP1 | GP2 | GP3 | GP4 | GP5

For applications that process I/Q data, such as the I/Q Analyzer or optional applications, and only if the Digital Baseband Interface (R&S FSW-B17) is available.

Defines triggering of the measurement directly via the LVDS connector. The parameter specifies which general purpose bit (0 to 5) will provide the trigger data.

The assignment of the general purpose bits used by the Digital IQ trigger to the LVDS connector pins is provided in "[Digital I/Q](#)" on page 53.

*RST: IMMediate

Example:

TRIG:SOUR EXT

Selects the external trigger input as source of the trigger signal

Manual operation: See "Trigger Source" on page 52
 See "Free Run" on page 53
 See "External Trigger 1/2/3" on page 53
 See "Baseband Power" on page 53
 See "Digital I/Q" on page 53
 See "RF Power" on page 54
 See "I/Q Power" on page 54
 See "Power Sensor" on page 54

TRIGger[:SEQuence]:TIME:RINTerval <Interval>

This command defines the repetition interval for the time trigger.

Parameters:

<Interval> 2.0 ms to 5000
 Range: 2 ms to 5000 s
 *RST: 1.0 s

Example:

TRIG:SOUR TIME
 Selects the time trigger input for triggering.
 TRIG:TIME:RINT 50
 The sweep starts every 50 s.

Manual operation: See "Repetition Interval" on page 55

11.4.2.2 Configuring the Trigger Output

The following commands are required to send the trigger signal to one of the variable TRIGGER INPUT/OUTPUT connectors. The tasks for manual operation are described in "Trigger 2/3" on page 56.

OUTPut:TRIGger<port>:DIRection.....	120
OUTPut:TRIGger<port>:LEVel.....	121
OUTPut:TRIGger<port>:OTYPe.....	121
OUTPut:TRIGger<port>:PULSe:IMMediate.....	122
OUTPut:TRIGger<port>:PULSe:LENGth.....	122

OUTPut:TRIGger<port>:DIRection <Direction>

This command selects the trigger direction.

Suffix:

<port> Selects the trigger port to which the output is sent.
 2 = trigger port 2 (front)
 3 = trigger port 3 (rear)

Parameters:

<Direction>

INPut

Port works as an input.

OUTPut

Port works as an output.

*RST: INPut

Manual operation: See ["Trigger 2/3"](#) on page 56**OUTPut:TRIGger<port>:LEVel <Level>**

This command defines the level of the signal generated at the trigger output.

This command works only if you have selected a user defined output with [OUTPut:TRIGger<port>:OTYPe](#).**Suffix:**

<port>

Selects the trigger port to which the output is sent.

2 = trigger port 2 (front)

3 = trigger port 3 (rear)

Parameters:

<Level>

HIGH

TTL signal.

LOW

0 V

*RST: LOW

Manual operation: See ["Trigger 2/3"](#) on page 56
See ["Level"](#) on page 57**OUTPut:TRIGger<port>:OTYPe <OutputType>**

This command selects the type of signal generated at the trigger output.

Suffix:

<port>

Selects the trigger port to which the output is sent.

2 = trigger port 2 (front)

3 = trigger port 3 (rear)

Parameters:

<OutputType>

DEvice

Sends a trigger signal when the R&S FSW has triggered internally.

TARMed

Sends a trigger signal when the trigger is armed and ready for an external trigger event.

UDEfined

Sends a user defined trigger signal. For more information see [OUTPut:TRIGger<port>:LEVel](#).

*RST: DEvice

Manual operation: See "[Output Type](#)" on page 56

OUTPut:TRIGger<port>:PULSe:IMMediate

This command generates a pulse at the trigger output.

Suffix:

<port>

Selects the trigger port to which the output is sent.

2 = trigger port 2 (front)

3 = trigger port 3 (rear)

Usage:

Event

Manual operation: See "[Send Trigger](#)" on page 57

OUTPut:TRIGger<port>:PULSe:LENGth <Length>

This command defines the length of the pulse generated at the trigger output.

Suffix:

<port>

Selects the trigger port to which the output is sent.

2 = trigger port 2 (front)

3 = trigger port 3 (rear)

Parameters:

<Length>

Pulse length in seconds.

Manual operation: See "[Pulse Length](#)" on page 57

11.4.3 Configuring Data Acquisition

The following commands are required to configure the actual data acquisition.

Configuring data acquisition is only possible for the MSRA Master channel. In MSRA application channels, these commands define the analysis interval (see [chapter 11.9, "Commands Specific to MSRA Applications"](#), on page 144). Be sure to select the correct measurement channel before executing these commands.

[SENSe:]IQ:BANDwidth BWIDth:MODE.....	123
[SENSe:]IQ:BANDwidth BWIDth:RESolution.....	123
[SENSe:]IQ:FFT:ALGorithm.....	124
[SENSe:]IQ:FFT:LENGth.....	124
[SENSe:]IQ:FFT:WINDow:LENGth.....	125
[SENSe:]IQ:FFT:WINDow:OVERlap.....	125
[SENSe:]IQ:FFT:WINDow:TYPE.....	125
TRACe:IQ:BWIDth.....	126
TRACe:IQ:RLENGth.....	126
TRACe:IQ:SRATE.....	127
TRACe:IQ:TPISample?.....	127
TRACe:IQ:WBAND[:STATe].....	128
TRACe:IQ:WBAND:MBWIDTH.....	128

[SENSe:]IQ:BANDwidth|BWIDth:MODE <Mode>

This command defines how the resolution bandwidth is determined.

Parameters:

<Mode>

AUTO | MANual | FFT

AUTO

(Default) The RBW is determined automatically depending on the sample rate and record length.

MANual

The user-defined RBW is used and the (FFT) window length (and possibly the sample rate) are adapted accordingly. The RBW is defined using the [SENSe:]IQ:BANDwidth|BWIDth:RESolution command.

FFT

The RBW is determined by the FFT parameters.

*RST: AUTO

Example:

```
IQ:BAND:MODE MAN
```

Switches to manual RBW mode.

```
IQ:BAND:RES 120000
```

Sets the RBW to 120 kHz.

Usage:

SCPI confirmed

Manual operation: See "RBW" on page 60

[SENSe:]IQ:BANDwidth|BWIDth:RESolution <Bandwidth>

This command defines the resolution bandwidth manually if [SENSe:]IQ:BANDwidth|BWIDth:MODE is set to MAN.

Defines the resolution bandwidth. The available RBW values depend on the sample rate and record length.

Parameters:

<Bandwidth> refer to data sheet
 *RST: RBW: AUTO mode is used

Example:

IQ:BAND:MODE MAN
 Switches to manual RBW mode.
 IQ:BAND:RES 120000
 Sets the RBW to 120 kHz.

Usage: SCPI confirmed

Manual operation: See "RBW" on page 60

[SENSe:]IQ:FFT:ALGORITHM <Method>

Defines the FFT calculation method.

Parameters:

<Method> **SINGLE**
 One FFT is calculated for the entire record length; if the FFT length is larger than the record length (see [SENSe:]IQ:FFT:LENGth and TRACe:IQ:RLENGth), zeros are appended to the captured data.

AVERAge

Several overlapping FFTs are calculated for each record; the results are averaged to determine the final FFT result for the record.

The user-defined window length and window overlap are used (see [SENSe:]IQ:FFT:WINDow:LENGth and [SENSe:]IQ:FFT:WINDow:OVERlap).

*RST: AVER

Example: IQ:FFT:ALG SING

Usage: SCPI confirmed

Manual operation: See "Transformation Algorithm" on page 61

[SENSe:]IQ:FFT:LENGth <NoOfBins>

Defines the number of frequency points determined by each FFT calculation. The more points are used, the higher the resolution in the spectrum becomes, but the longer the calculation takes.

Parameters:

<NoOfBins> integer value
 Range: 3 to 524288
 *RST: 4096

Example: IQ:FFT:LENG 2048

Usage: SCPI confirmed

Manual operation: See ["FFT Length"](#) on page 61

[SENSe:]IQ:FFT:WINDow:LENGth <NoOfFFT>

Defines the number of samples to be included in a single FFT window when multiple FFT windows are used.

Parameters:

<NoOfFFT> integer value
 Range: 3 to 1001
 *RST: 1001

Example: IQ:FFT:WIND:LENG 500

Usage: SCPI confirmed

Manual operation: See ["Window Length"](#) on page 62

[SENSe:]IQ:FFT:WINDow:OVERlap <Rate>

Defines the part of a single FFT window that is re-calculated by the next FFT calculation.

Parameters:

<Rate> double value
 Percentage rate
 Range: 0 to 1
 *RST: 0.75

Example: IQ:FFT:WIND:OVER 0.5
 Half of each window overlaps the previous window in FFT calculation.

Usage: SCPI confirmed

Manual operation: See ["Window Overlap"](#) on page 62

[SENSe:]IQ:FFT:WINDow:TYPE <Function>

In the I/Q Analyzer you can select one of several FFT window types.

Parameters:

<Function>

BLACkharris
Blackman-Harris

FLATtop
Flattop

GAUSsian
Gauss

RECTangular
Rectangular

P5
5-Term

*RST: FLAT

Example: IQ:FFT:WIND:TYPE GAUS

Usage: SCPI confirmed

Manual operation: See ["Window Function"](#) on page 61

TRACe:IQ:BWIDth

This command defines or queries the bandwidth of the resampling filter.

The bandwidth of the resampling filter depends on the sample rate.

Parameters:

<Bandwidth> For details on the maximum bandwidth see [chapter A.3, "Sample Rate and Maximum Usable I/Q Bandwidth for RF Input"](#), on page 150.

Manual operation: See ["Analysis Bandwidth"](#) on page 59

TRACe:IQ:RLENgth <NoOfSamples>

This command sets the record length for the acquired I/Q data.

Increasing the record length also increases the measurement time.

Note: Alternatively, you can define the measurement time using the `SENS:SWE:TIME` command.

Parameters:

<NoOfSamples> Number of samples to record.
For digital input via the Digital Baseband Interface (R&S FSW-B17) the valid number of samples is described in [chapter A.4, "Sample Rates and Bandwidths for Digital I/Q Data"](#), on page 157.

*RST: 1001

Example: TRAC:IQ:RLEN 256

Manual operation: See ["Record Length"](#) on page 60

TRACe:IQ:SRATe <SampleRate>

This command sets the final user sample rate for the acquired I/Q data. Thus, the user sample rate can be modified without affecting the actual data capturing settings on the R&S FSW.

Note: The smaller the user sample rate, the smaller the usable I/Q bandwidth, see [chapter A.3, "Sample Rate and Maximum Usable I/Q Bandwidth for RF Input"](#), on page 150.

Parameters:

<SampleRate> The valid sample rates are described in [chapter A.3, "Sample Rate and Maximum Usable I/Q Bandwidth for RF Input"](#), on page 150.

Range: 100 Hz to 10 GHz continuously adjustable;
*RST: 32 MHz

Manual operation: See ["Sample Rate"](#) on page 58

TRACe:IQ:TPISample?

This command queries the time offset between the sample start and the trigger event (trigger point in sample = TPIS). Since the R&S FSW usually samples with a much higher sample rate than the specific application actually requires, the trigger point determined internally is much more precise than the one determined from the (down-sampled) data in the application. Thus, the TPIS indicates the offset between the sample start and the actual trigger event.

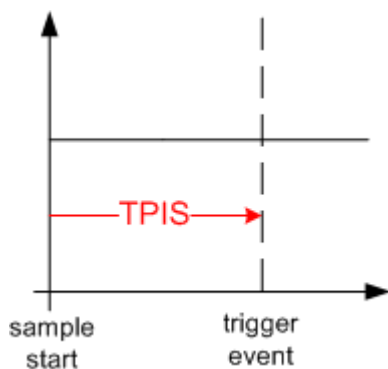

This value can only be determined in triggered measurements using external or IFPower triggers, otherwise the value is 0.

This command is not available if the Digital Baseband Interface (R&S FSW-B17) is active and not for bandwidths > 80 MHz.

Example: TRACe:IQ:TPIS?
Result for a sample rate of 1 MHz: between 0 and 1/1 MHz, i.e. between 0 and 1 μ s (the duration of 1 sample).

Usage: Query only

TRACe:IQ:WBANd[:STATe] <State>

This command determines whether the wideband provided by bandwidth extension options is used or not (if installed).

Parameters:

<State>

ON | OFF

ON

If enabled, installed bandwidth extension options can be used. They are activated for bandwidths > 80 MHz, if the bandwidth is not restricted by the [TRACe:IQ:WBANd:MBWIDTH](#) command.

Otherwise, the currently available maximum bandwidth is allowed (see [chapter A.3, "Sample Rate and Maximum Usable I/Q Bandwidth for RF Input"](#), on page 150).

This parameter corresponds to the "Auto" setting in manual operation (with [TRACe:IQ:WBANd:MBWIDTH](#) 320 MHz).

OFF

The bandwidth extension options R&S FSW-B500/-B320/-B160 are deactivated; the maximum analysis bandwidth is restricted to 80 MHz.

This parameter corresponds to the "80 MHz" setting in manual operation.

*RST: ON

Manual operation: See ["Maximum Bandwidth"](#) on page 59

TRACe:IQ:WBANd:MBWIDTH <Limit>

Restricts the maximum analysis bandwidth.

Parameters:

<Limit>

80 MHz

Restricts the analysis bandwidth to a maximum of 80 MHz. The bandwidth extension option R&S FSW-B160/-B320/-B500 is deactivated.

`TRACe: IQ:WBANd[:STATe]` is set to OFF.

160 MHz

Restricts the analysis bandwidth to a maximum of 160 MHz. The bandwidth extension option R&S FSW-B320 is deactivated. (Not available or required if bandwidth extension option R&S FSW-B500 is installed.)

`TRACe: IQ:WBANd[:STATe]` is set to ON.

500 MHz | 320 MHz | MAX

All installed bandwidth extension options are activated. The currently available maximum bandwidth is allowed (see [chapter A.3, "Sample Rate and Maximum Usable I/Q Bandwidth for RF Input"](#), on page 150).

`TRACe: IQ:WBANd[:STATe]` is set to ON.

*RST: maximum available

Default unit: Hz

Manual operation: See ["Maximum Bandwidth"](#) on page 59

11.4.4 Adjusting Settings Automatically

The following remote commands are required to adjust settings automatically in a remote environment. These commands are only available for the MSRA Master channel. The tasks for manual operation are described in [chapter 7.10, "Automatic Settings"](#), on page 67.



Settings related to data acquisition (measurement time, hysteresis) can only be adjusted in the MSRA Master, not in the applications.

<code>[SENSe:]ADJust:ALL</code>	129
<code>[SENSe:]ADJust:CONFigure:DURation</code>	130
<code>[SENSe:]ADJust:CONFigure:DURation:MODE</code>	130
<code>[SENSe:]ADJust:FREQuency</code>	131
<code>[SENSe:]ADJust:CONFigure:HYSteresis:LOWer</code>	131
<code>[SENSe:]ADJust:CONFigure:HYSteresis:UPPer</code>	131
<code>[SENSe:]ADJust:LEVel</code>	132

[SENSe:]ADJust:ALL

This command initiates a measurement to determine and set the ideal settings for the current task automatically (only once for the current measurement).

This includes:

- Reference level

Example: ADJ:ALL

Usage: Event

Manual operation: See ["Adjusting all Determinable Settings Automatically \(Auto All\)"](#) on page 67

[SENSe:]ADJust:CONFigure:DURation <Duration>

In order to determine the ideal reference level, the R&S FSW performs a measurement on the current input data. This command defines the length of the measurement if [SENSe:]ADJust:CONFigure:DURation:MODE is set to MANual.

Parameters:

<Duration> Numeric value in seconds
 Range: 0.001 to 16000.0
 *RST: 0.001
 Default unit: s

Example: ADJ:CONF:DUR:MODE MAN
 Selects manual definition of the measurement length.
 ADJ:CONF:LEV:DUR 5ms
 Length of the measurement is 5 ms.

Manual operation: See ["Changing the Automatic Measurement Time \(Meastime Manual\)"](#) on page 68

[SENSe:]ADJust:CONFigure:DURation:MODE <Mode>

In order to determine the ideal reference level, the R&S FSW performs a measurement on the current input data. This command selects the way the R&S FSW determines the length of the measurement .

Parameters:

<Mode> **AUTO**
 The R&S FSW determines the measurement length automatically according to the current input data.
MANual
 The R&S FSW uses the measurement length defined by [SENSe:]ADJust:CONFigure:DURation on page 130.
 *RST: AUTO

Manual operation: See ["Resetting the Automatic Measurement Time \(Meastime Auto\)"](#) on page 68
 See ["Changing the Automatic Measurement Time \(Meastime Manual\)"](#) on page 68

[SENSe:]ADJJust:FREQuency

This command sets the center frequency to the highest signal level in the current frequency range.

Example: ADJ:FREQ

Usage: Event

Manual operation: See ["Adjusting the Center Frequency Automatically \(Auto Freq\)"](#) on page 67

[SENSe:]ADJJust:CONFIgure:HYSTerisis:LOWer <Threshold>

When the reference level is adjusted automatically using the [\[SENSe:\]ADJJust:LEVEl](#) on page 132 command, the internal attenuators and the preamplifier are also adjusted. In order to avoid frequent adaptation due to small changes in the input signal, you can define a hysteresis. This setting defines a lower threshold the signal must fall below (compared to the last measurement) before the reference level is adapted automatically.

This setting can only be adjusted in the MSRA Master, not in the applications.

Parameters:

<Threshold> Range: 0 dB to 200 dB
*RST: +1 dB
Default unit: dB

Example:

SENS:ADJ:CONF:HYST:LOW 2

For an input signal level of currently 20 dBm, the reference level will only be adjusted when the signal level falls below 18 dBm.

Manual operation: See ["Lower Level Hysteresis"](#) on page 69

[SENSe:]ADJJust:CONFIgure:HYSTerisis:UPPer <Threshold>

When the reference level is adjusted automatically using the [\[SENSe:\]ADJJust:LEVEl](#) on page 132 command, the internal attenuators and the preamplifier are also adjusted. In order to avoid frequent adaptation due to small changes in the input signal, you can define a hysteresis. This setting defines an upper threshold the signal must exceed (compared to the last measurement) before the reference level is adapted automatically.

This setting can only be adjusted in the MSRA Master, not in the applications.

Parameters:

<Threshold> Range: 0 dB to 200 dB
*RST: +1 dB
Default unit: dB

Example:

SENS:ADJ:CONF:HYST:UPP 2

Example:

For an input signal level of currently 20 dBm, the reference level will only be adjusted when the signal level rises above 22 dBm.

Manual operation: See ["Upper Level Hysteresis"](#) on page 68

[SENSe:]ADJust:LEVel

This command initiates a single (internal) measurement that evaluates and sets the ideal reference level for the current input data and measurement settings. This ensures that the settings of the RF attenuation and the reference level are optimally adjusted to the signal level without overloading the R&S FSW or limiting the dynamic range by an S/N ratio that is too small.

Example: ADJ:LEV

Usage: Event

Manual operation: See ["Setting the Reference Level Automatically \(Auto Level\)"](#) on page 68

11.5 Capturing Data and Performing Sweeps

The only true measurement in MSRA mode in which I/Q data from the input signal is captured and stored is performed by the MSRA Master. This data acquisition is performed as in the I/Q Analyzer application, i.e. a specified frequency span of the input signal is swept for a specified measurement time.



As soon as data has been stored to the capture buffer successfully, a status bit (#9) in the STAT:OPER register is set (see [chapter 11.7.1, "STATus:OPERation Register"](#), on page 141). Once the bit has been set, the device under test can already be reconfigured while the R&S FSW performs analysis on the captured data. For measurements that require long measurement times and comprehensive analysis tasks, using the "capture finished" information can reduce the overall measurement time significantly.

See also:

- [INITiate:REFresh](#) on page 146

ABORT	133
INITiate:CONMeas	133
INITiate:CONTinuous	134
INITiate[:IMMediate]	134
INITiate:SEQuencer:ABORT	134
INITiate:SEQuencer:IMMediate	135
INITiate:SEQuencer:MODE	135
INITiate:SEQuencer:REFresh[:ALL]	136
[SENSe:]SWEep:POINts	136
[SENSe:]SWEep:TIME	136
SYSTem:SEQuencer	137

ABORt

This command aborts a current measurement and resets the trigger system.

To prevent overlapping execution of the subsequent command before the measurement has been aborted successfully, use the `*OPC?` or `*WAI` command after `ABOR` and before the next command.

For details see the "Remote Basics" chapter in the R&S FSW User Manual.

To abort a sequence of measurements by the Sequencer, use the `INITiate:SEQuencer:ABORt` on page 134 command.

Note on blocked remote control programs:

If a sequential command cannot be completed, for example because a triggered sweep never receives a trigger, the remote control program will never finish and the remote channel to the R&S FSW is blocked for further commands. In this case, you must interrupt processing on the remote channel first in order to abort the measurement.

To do so, send a "Device Clear" command from the control instrument to the R&S FSW on a parallel channel to clear all currently active remote channels. Depending on the used interface and protocol, send the following commands:

- **Visa:** `viClear()`
- **GPIB:** `ibclr()`
- **RSIB:** `RSDLLibclr()`

Now you can send the `ABORt` command on the remote channel performing the measurement.

Example: `ABOR; :INIT:IMM`
Aborts the current measurement and immediately starts a new one.

Example: `ABOR; *WAI`
`INIT:IMM`
Aborts the current measurement and starts a new one once abortion has been completed.

Usage: SCPI confirmed

INITiate:CONMeas

This command restarts a (single) measurement that has been stopped (using `INIT:CONT OFF`) or finished in single sweep mode.

The measurement is restarted at the beginning, not where the previous measurement was stopped.

As opposed to `INITiate[:IMMediate]`, this command does not reset traces in maxhold, minhold or average mode. Therefore it can be used to continue measurements using maxhold or averaging functions.

Manual operation: See "Continue Single Sweep" on page 64

INITiate:CONTInuous <State>

This command controls the sweep mode.

Note that in single sweep mode, you can synchronize to the end of the measurement with *OPC, *OPC? or *WAI. In continuous sweep mode, synchronization to the end of the measurement is not possible. Thus, it is not recommended that you use continuous sweep mode in remote control, as results like trace data or markers are only valid after a single sweep end synchronization.

For details on synchronization see the "Remote Basics" chapter in the R&S FSW User Manual.

If the sweep mode is changed for a measurement channel while the Sequencer is active (see [INITiate:SEQuencer:IMMediate](#) on page 135) the mode is only considered the next time the measurement in that channel is activated by the Sequencer.

Parameters:

<State> ON | OFF | 0 | 1
 ON | 1
 Continuous sweep
 OFF | 0
 Single sweep
 *RST: 1

Example:

```
INIT:CONT OFF
Switches the sweep mode to single sweep .
INIT:CONT ON
Switches the sweep mode to continuous sweep .
```

Manual operation: See "[Continuous Sweep/RUN CONT](#)" on page 63

INITiate[:IMMediate]

This command starts a (single) new measurement.

You can synchronize to the end of the measurement with *OPC, *OPC? or *WAI.

For details on synchronization see the "Remote Basics" chapter in the R&S FSW User Manual.

Manual operation: See "[Single Sweep/ RUN SINGLE](#)" on page 64

INITiate:SEQuencer:ABORt

This command stops the currently active sequence of measurements. The Sequencer itself is not deactivated, so you can start a new sequence immediately using [INITiate:SEQuencer:IMMediate](#) on page 135.

To deactivate the Sequencer use [SYSTem:SEQuencer](#) on page 137.

Usage: Event

Manual operation: See "[Sequencer State](#)" on page 25

INITiate:SEQuencer:IMMEDIATE

This command starts a new sequence of measurements by the Sequencer. Its effect is similar to the `INITiate[:IMMEDIATE]` command used for a single measurement.

Before this command can be executed, the Sequencer must be activated (see [SYSTem:SEQuencer](#) on page 137).

Example:

```
SYST:SEQ ON
Activates the Sequencer.
INIT:SEQ:MODE SING
Sets single sequence mode so each active measurement will be
performed once.
INIT:SEQ:IMM
Starts the sequential measurements.
```

Usage: Event

Manual operation: See "[Sequencer State](#)" on page 25

INITiate:SEQuencer:MODE <Mode>

This command selects the way the R&S FSW application performs measurements sequentially.

Before this command can be executed, the Sequencer must be activated (see [SYSTem:SEQuencer](#) on page 137).

A detailed programming example is provided in the "Operating Modes" chapter in the R&S FSW User Manual.

Note: In order to synchronize to the end of a sequential measurement using `*OPC`, `*OPC?` or `*WAI` you must use `SINGLE` Sequence mode.

For details on synchronization see the "Remote Basics" chapter in the R&S FSW User Manual.

Parameters:

<Mode>

SINGLE

Each measurement is performed once (regardless of the channel's sweep mode), considering each channels' sweep count, until all measurements in all active channels have been performed.

CONTInuous

The measurements in each active channel are performed one after the other, repeatedly (regardless of the channel's sweep mode), in the same order, until the Sequencer is stopped.

CDEFined

First, a single sequence is performed. Then, only those channels in continuous sweep mode (`INIT:CONT ON`) are repeated.

*RST: CONTInuous

Example: SYST:SEQ ON
 Activates the Sequencer.
 INIT:SEQ:MODE SING
 Sets single sequence mode so each active measurement will be performed once.
 INIT:SEQ:IMM
 Starts the sequential measurements.

Manual operation: See "[Sequencer Mode](#)" on page 25

INITiate:SEQuencer:REFResh[:ALL]

This function is only available if the Sequencer is deactivated ([SYSTEM:SEQuencer](#) [SYST:SEQ:OFF](#)) and only in MSRA or MSRT mode.

The data in the capture buffer is re-evaluated by all active MSRA/MSRT applications.

Example: SYST:SEQ:OFF
 Deactivates the scheduler
 INIT:CONT OFF
 Switches to single sweep mode.
 INIT;*WAI
 Starts a new data measurement and waits for the end of the sweep.
 INIT:SEQ:REFR
 Refreshes the display for all channels.

Usage: Event

Manual operation: See "[Refresh All](#)" on page 25

[SENSe:]SWEep:POINts <SweepPoints>

This command defines the number of measurement points analyzed during a sweep.

Example: SWE:POIN 251

Usage: SCPI confirmed

Manual operation: See "[Sweep Points](#)" on page 63

[SENSe:]SWEep:TIME <Time>

This command defines the sweep (or: data capture) time.

Parameters:

<Time> refer to data sheet
 *RST: depends on current settings (determined automatically)

Example: SWE:TIME 10s

Usage: SCPI confirmed

Manual operation: See ["Meas Time"](#) on page 59

SYSTem:SEQuencer <State>

This command turns the Sequencer on and off. The Sequencer must be active before any other Sequencer commands (`INIT:SEQ...`) are executed, otherwise an error will occur.

A detailed programming example is provided in the "Operating Modes" chapter in the R&S FSW User Manual.

Parameters:

<State>

ON | OFF | 0 | 1

ON | 1

The Sequencer is activated and a sequential measurement is started immediately.

OFF | 0

The Sequencer is deactivated. Any running sequential measurements are stopped. Further Sequencer commands (`INIT:SEQ...`) are not available.

*RST: 0

Example:

```
SYST:SEQ ON
```

Activates the Sequencer.

```
INIT:SEQ:MODE SING
```

Sets single Sequencer mode so each active measurement will be performed once.

```
INIT:SEQ:IMM
```

Starts the sequential measurements.

```
SYST:SEQ OFF
```

Manual operation: See ["Sequencer State"](#) on page 25

11.6 Retrieving Results

The measurement results are output in the form of a list, three different formats can be selected for this list (see [TRACe:IQ:DATA:FORMat](#) on page 139).

For details on formats refer to [chapter A.1, "Reference: Format Description for I/Q Data Files"](#), on page 149.



The applications can only receive data that is available in the capture buffer. As soon as data has been stored to the capture buffer successfully, a status bit (#9) in the `STAT:OPER` register is set (see [chapter 11.7.1, "STATus:OPERation Register"](#), on page 141).

FORMat[:DATA].....	138
TRACe:IQ:DATA?.....	138
TRACe:IQ:DATA:FORMat.....	139
TRACe:IQ:DATA:MEMory?.....	139

FORMat[:DATA] <Format>

This command selects the data format that is used for transmission of trace data from the R&S FSW to the controlling computer.

Note that the command has no effect for data that you send to the R&S FSW. The R&S FSW automatically recognizes the data it receives, regardless of the format.

Parameters:

<Format>

AScii

AScii format, separated by commas.

This format is almost always suitable, regardless of the actual data format. However, the data is not as compact as other formats may be.

REAL,32

32-bit IEEE 754 floating-point numbers in the "definite length block format".

In the Spectrum application, the format setting `REAL` is used for the binary transmission of trace data.

For I/Q data, 8 bytes per sample are returned for this format setting.

*RST: ASCII

Example: FORM REAL, 32

Usage: SCPI confirmed

TRACe:IQ:DATA?

This command queries the captured data from measurements with the I/Q Analyzer.

To get the results, the command also initiates a measurement with the current settings of the R&S FSW.

Return values:

<Results>

Measured voltage for I and Q component for each sample that has been captured during the measurement.

For more information on I/Q data processing modes see the R&S FSW I/Q Analyzer and I/Q Input User Manual.

The data format depends on `FORMat [:DATA]`.

Default unit: V

Example:

```
TRAC:IQ:STAT ON
Enables acquisition of I/Q data
TRAC:IQ:SET NORM,10MHz,32MHz,EXT,POS,0,4096
Measurement configuration:
Sample Rate = 32 MHz
Trigger Source = External
Trigger Slope = Positive
Pretrigger Samples = 0
Number of Samples = 4096
FORMat REAL,32
Selects format of response data
TRAC:IQ:DATA?
Starts measurement and reads results
```

Usage: Query only

TRACe:IQ:DATA:FORMat <Format>

This command selects the order of the I/Q data.

For details see [chapter A.1, "Reference: Format Description for I/Q Data Files"](#), on page 149.

Parameters:

<Format>

COMPAtible | IQBLock | IQPair

COMPAtible

I and Q values are separated and collected in blocks: A block (512k) of I values is followed by a block (512k) of Q values, followed by a block of I values, followed by a block of Q values etc.
(I,I,I,I,Q,Q,Q,I,I,I,I,I,Q,Q,Q,Q...)

IQBLock

First all I-values are listed, then the Q-values
(I,I,I,I,I,I,...Q,Q,Q,Q,Q,Q)

IQPair

One pair of I/Q values after the other is listed
(I,Q,I,Q,I,Q...).

*RST: IQBL

TRACe:IQ:DATA:MEMory? [<OffsetSamples>,<NoOfSamples>]

This command queries the I/Q data currently stored in the memory of the R&S FSW.

By default, the command returns all I/Q data in the memory. You can, however, narrow down the amount of data that the command returns using the optional parameters.

Parameters:

<OffsetSamples> Selects an offset at which the output of data should start in relation to the first data. If omitted, all captured samples are output, starting with the first sample.

Range: 0 to <# of samples> – 1, with <# of samples> being the maximum number of captured values

*RST: 0

<NoOfSamples> Number of samples you want to query, beginning at the offset you have defined. If omitted, all captured samples (starting at offset) are output.

Range: 1 to <# of samples> - <offset samples> with <# of samples> maximum number of captured values

*RST: <# of samples>

Return values:

<IQData> Measured value pair (I,Q) for each sample that has been recorded.

The data format depends on `FORMat [:DATA]`.

Default unit: V

Example:

```
TRAC:IQ:STAT ON
```

Enables acquisition of I/Q data

```
TRAC:IQ:SET NORM,10MHz,32MHz,EXT,POS,100,4096
```

Measurement configuration:

Sample Rate = 32 MHz

Trigger Source = External

Trigger Slope = Positive

Pretrigger Samples = 100

Number of Samples = 4096

```
INIT;*WAI
```

Starts measurement and wait for sync

```
FORMat REAL,32
```

Determines output format

To read the results:

```
TRAC:IQ:DATA:MEM?
```

Reads all 4096 I/Q data

```
TRAC:IQ:DATA:MEM? 0,2048
```

Reads 2048 I/Q data starting at the beginning of data acquisition

```
TRAC:IQ:DATA:MEM? 2048,1024
```

Reads 1024 I/Q data from half of the recorded data

```
TRAC:IQ:DATA:MEM? 100,512
```

Reads 512 I/Q data starting at the trigger point (<Pretrigger Samples> was 100)

Usage:

Query only

11.7 Querying the Status Registers

The R&S FSW-I/Q Analyzer uses the standard status registers of the R&S FSW.

The MSRA operating mode uses an additional bit in the `STATus:OPERation` register.

This register and the commands required to query its contents are described here.

For details on the common R&S FSW status registers refer to the description of remote control basics in the R&S FSW User Manual.



*RST does not influence the status registers.

- [STATus:OPERation Register](#)..... 141
- [Commands to Query the STATus:OPERation Register](#)..... 142

11.7.1 STATus:OPERation Register

The `STATus:OPERation` register contains information on current activities of the R&S FSW. It also contains information on activities that have been executed since the last read out.

You can read out the register with `STATus:OPERation:CONDition?` on page 142 or `STATus:OPERation[:EVENT]?` on page 143.

Table 11-2: Meaning of the bits used in the `STATus:OPERation` register

Bit No.	Meaning
0	CALibrating This bit is set as long as the instrument is performing a calibration.
1-2	Not used
3	SWEeping Sweep is being performed in base unit (applications are not considered); identical to bit 4 In applications, this bit is not used.
4	MEASuring Measurement is being performed in base unit (applications are not considered); identical to bit 3 In applications, this bit is not used.
5	Waiting for TRigger Instrument is ready to trigger and waiting for trigger signal
6-7	Not used
8	HardCOpy in progress This bit is set while the instrument is printing a hardcopy.

Bit No.	Meaning
9	For data acquisition in MSRA/MSRT mode only: Multi-Standard capture finish This bit is set if a data acquisition measurement was completed successfully in MSRA/MSRT operating mode and data is available for evaluation.
10	Range completed This bit is set when a range in the sweep list has been completed if "Stop after Range" has been activated.
11-14	Not used
15	This bit is always 0.

11.7.2 Commands to Query the STATus:OPERation Register

The following commands are required to query the contents of the STATus:OPERation register.

STATus:OPERation:CONDition?.....	142
STATus:OPERation:ENABle?.....	142
STATus:OPERation:NTRansition?.....	143
STATus:OPERation:PTRansition?.....	143
STATus:OPERation[:EVENT]j?.....	143

STATus:OPERation:CONDition? <ChannelName>

This comand reads out the CONDition section of the status register.

The command does not delete the contents of the EVENT section.

Query parameters:

<ChannelName> String containing the name of the channel.
The parameter is optional. If you omit it, the command works for the currently active channel.

Usage: Query only

STATus:OPERation:ENABle? <SumBit>,<ChannelName>

This command controls the ENABle part of the register.

The ENABle part allows true conditions in the EVENT part of the status register to be reported in the summary bit. If a bit is 1 in the enable register and its associated event bit transitions to true, a positive transition will occur in the summary bit reported to the next higher level.

Parameters:

<SumBit> Range: 0 to 65535

<ChannelName> String containing the name of the channel.
The parameter is optional. If you omit it, the command works for the currently active channel.

Usage: Query only

STATus:OPERation:NTRansition? <SumBit>,<ChannelName>

This command controls the Negative TRansition part of a register.

Setting a bit causes a 1 to 0 transition in the corresponding bit of the associated register. The transition also writes a 1 into the associated bit of the corresponding EVENT register.

Parameters:

<SumBit> Range: 0 to 65535

<ChannelName> String containing the name of the channel.
The parameter is optional. If you omit it, the command works for the currently active channel.

Usage: Query only

STATus:OPERation:PTRansition? <SumBit>,<ChannelName>

This command controls the Positive TRansition part of the register.

Setting a bit causes a 0 to 1 transition in the corresponding bit of the associated register. The transition also writes a 1 into the associated bit of the corresponding EVENT register.

Parameters:

<SumBit> Range: 0 to 65535

<ChannelName> String containing the name of the channel.
The parameter is optional. If you omit it, the command works for the currently active channel.

Usage: Query only

STATus:OPERation[:EVENT]? <ChannelName>

This command queries the contents of the EVENT section of the status register.

A query deletes the contents of the EVENT section.

Query parameters:

<ChannelName> String containing the name of the channel.
The parameter is optional. If you omit it, the command works for the currently active channel.

Return values:

<RegisterContents> Range: 0 to 32767

Usage: Query only

11.8 Analyzing MSRA Measurements

The data that was captured by the MSRA Master can be analyzed in various different applications.

The analysis settings and functions available in MSRA mode are those described for the individual applications. The MSRA Master is in effect an I/Q Analyzer application and has the same analysis functions and settings.

See the R&S FSW I/Q Analyzer User Manual for a description of the analysis functions and settings available for the I/Q Analyzer and thus the MSRA Master.



The commands required to configure the MSRA-specific analysis line are described in [chapter 11.9, "Commands Specific to MSRA Applications"](#), on page 144.

11.9 Commands Specific to MSRA Applications

Most commands for the MSRA applications are identical to those described for the individual applications. However, some specific commands are available for the MSRA applications only.

Configuring the analysis interval

The commands required to configure the application data extracts and analysis intervals vary depending on the application. See the corresponding application manuals for details.

For the I/Q Analyzer, the commands are the same as those used to define the actual data acquisition (see [chapter 11.4.3, "Configuring Data Acquisition"](#), on page 122. In MSRA application channels, these commands define the analysis interval. Be sure to select the correct measurement channel before executing these commands.

Useful commands for configuring the analysis interval described elsewhere:

- [TRACe:IQ:SRATe](#) on page 127
- [TRACe:IQ:BWIDth](#) on page 126
- [TRACe:IQ:RLENgth](#) on page 126
- [\[SENSe:\]SWEep:TIME](#) on page 136

Remote commands exclusive to MSRA applications

The following commands are only available for MSRA application channels:

CALCulate:IQ:MODE	145
CALCulate:MSRA:ALINe:SHOW	145
CALCulate:MSRA:ALINe[VALue]	145
CALCulate:MSRA:WINDow<n>:IVAL?	145
INITiate:REFresh	146
[SENSe:]MSRA:CAPTure:OFFSet	146

CALCulate:IQ:MODE <EvalMode>

This command defines whether the captured I/Q data is evaluated directly, or if it is converted (via FFT) to spectral or time data first.

It is currently only available for I/Q Analyzer applications in multistandard mode (not the MSRA Master).

Parameters:

<EvalMode>

TDOMain

Evaluation in time domain (zero span).

FDOMain

Evaluation in frequency domain.

IQ

Evaluation using I/Q data.

CALCulate:MSRA:ALINE:SHOW

This command defines whether or not the analysis line is displayed in all time-based windows in all MSRA applications and the MSRA Master.

Note: even if the analysis line display is off, the indication whether or not the currently defined line position lies within the analysis interval of the active application remains in the window title bars.

Parameters:

<State>

ON | OFF

*RST: ON

Manual operation: See "[Show Line](#)" on page 71

CALCulate:MSRA:ALINE[:VALue] <Position>

This command defines the position of the analysis line for all time-based windows in all MSRA applications and the MSRA Master.

Parameters:

<Position>

Position of the analysis line in seconds. The position must lie within the measurement time of the MSRA measurement.

Default unit: s

Manual operation: See "[Position](#)" on page 71

CALCulate:MSRA:WINDow<n>:IVAL?

This command queries the analysis interval for the window specified by the index <n>. This command is only available in application measurement channels, not the MSRA View or MSRA Master.

Return values:

<IntStart> Start value of the analysis interval in seconds
Default unit: s

<IntStop> Stop value of the analysis interval in seconds

Usage: Query only

INITiate:REFResh

This function is only available if the Sequencer is deactivated (`SYSTem:SEQuencer SYST:SEQ:OFF`) and only for applications in MSRA mode, not the MSRA Master.

The data in the capture buffer is re-evaluated by the currently active application only. The results for any other applications remain unchanged.

The application channel must be selected before this command can be executed (see `INSTrument[:SElect]` on page 92).

Example:

```
SYST:SEQ:OFF
Deactivates the scheduler
INIT:CONT OFF
Switches to single sweep mode.
INIT;*WAI
Starts a new data measurement and waits for the end of the
sweep.
INST:SEL 'IQ ANALYZER'
Selects the IQ Analyzer channel.
INIT:REFR
Refreshes the display for the I/Q Analyzer channel.
```

Usage: Event

Manual operation: See "[Refresh](#)" on page 63

[SENSe:]MSRA:CAPTure:OFFSet <Offset>

This setting is only available for applications in MSRA mode, not for the MSRA Master. It has a similar effect as the trigger offset in other measurements.

Parameters:

<Offset> This parameter defines the time offset between the capture buffer start and the start of the extracted application data. The offset must be a positive value, as the application can only analyze data that is contained in the capture buffer.

Range: 0 to <Record length>

*RST: 0

Manual operation: See "[Capture Offset](#)" on page 62

11.10 Programming Example: Analyzing MSR Signals

The following programming example demonstrates the use of the most important remote commands in MSRA mode. The example is based on the measurement example for manual operation described in [chapter 10, "Measurement Example: Analyzing MSR Signals"](#), on page 75.

```
//Preset
*RST

//Select Trace data output format: ASCII
FORM ASCII

//Switch to MSRA mode
INST:MODE MSR

//Set Sequencer in single mode
INIT:SEQ:MODE SING

//Preconfigure MSRA Master for general I/Q data acquisition

//Set initial center frequency
FREQ:CENT 1000MHz

//Set Level
DISP:WIND:TRAC:Y:SCAL:RLEV 10 dBm

//Set Trigger to External 1
:TRIG:SOUR EXT

//Set Sample Rate to 15MHz
:TRACe:IQ:SRATe 15E6

//Set Record Length to 1Msample -> AQT 21 ms
:TRACe:IQ:RLENgth 315000

//Create new measurement channel for I/Q Analyzer
INST:CRE IQ, 'IQ Analyzer'

//Set initial center frequency
FREQ:CENT 994.9 MHz

//Set Sample Rate to 1MHz
:TRACe:IQ:SRATe 1E6

//Set Record Length to 1Msample -> AQT 5 ms
:TRACe:IQ:RLENgth 5000

//Create measurement channel for 3GPP FDD BTS application
INST:CRE BWCD, '3GPP FDD BTS'
```

```
//Set initial center frequency
FREQ:CENT 997.5MHz

//Select Composite EVM vs slot in Window 1, EVM vs Chip in Window 3
//Result Summary remains in Window 2 as default
LAY:REPL:WIND '1',CEVM
LAY:ADD:WIND? '2',BEL,EVMC
//Result: new window is '5'

//Meas all tabs with synchronisation in MSRA mode
INIT:SEQ:IMM;*OPC?

//Retrieve Results of IQ Analyzer
INST:SEL 'IQ Analyzer'

//Check for Rising edge
:CALCulate:MARKer:X 1.14ms
:CALCulate:MARKer:Y?
:CALCulate:MARKer:X 1.156ms
:CALCulate:MARKer:Y?

//Retrieve Results from WCMDA
INST:SEL '3GPP FDD BTS'

//Retrieve Composite EVM results
TRAC1:DATA? TRACel

//Select Slot No 1
CDP:SLOT 1

//Search Peak value of Marker in EVM vs Chip
:CALC5:MARK1 ON
:CALC5:MARK1:MAX:PEAK

//Retrieve Chip and max EVM value
:CALC5:MARK1:X?;Y?
```

A Annex

A.1 Reference: Format Description for I/Q Data Files

This section describes how I/Q data is transferred to the memory during remote control (see [TRACe: IQ: DATA: FORMat](#) on page 139 command).

For details on the format of the individual values, see [chapter A.2, "Formats for Returned Values: ASCII Format and Binary Format"](#), on page 150.

For details on the format of I/Q export files (using the "I/Q Export" function), see the R&S FSW User Manual.

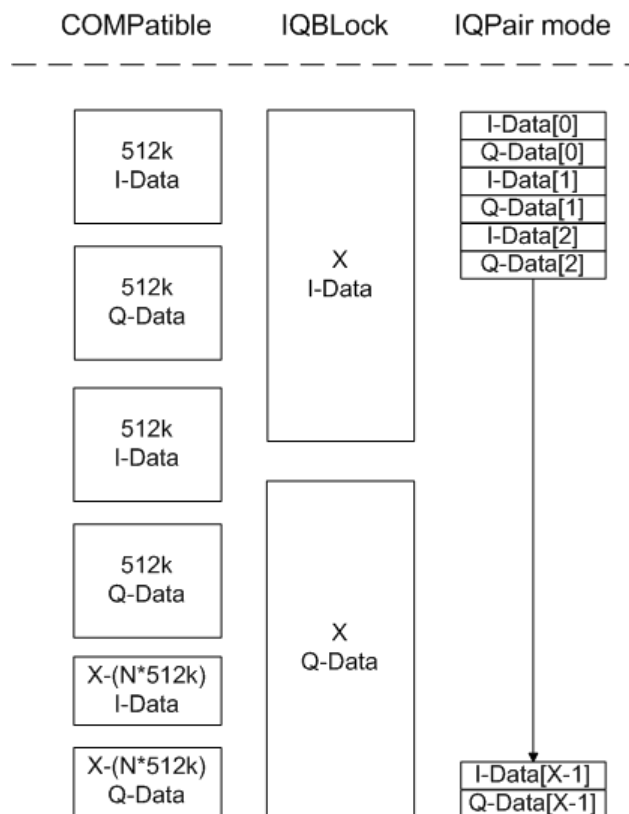

Fig. 1-1: I/Q data formats

Note: 512k corresponds to 524288 samples

For maximum performance, the formats "Compatible" or "IQPair" should be used. Furthermore, for large amounts of data, the data should be in binary format to improve performance.

In binary format, the number of I- and Q-data can be calculated as follows:

$$\# \text{ of I-Data} = \# \text{ of Q-Data} = \frac{\# \text{ of DataBytes}}{8}$$

For the format "QBLOCK", the offset of Q-data in the output buffer can be calculated as follows:

$$Q - Data - Offset = \frac{(\# \text{ of } DataBytes)}{2} + LengthIndicatorDigits$$

with "LengthIndicatorDigits" being the number of digits of the length indicator including the #. In the example above (#41024...), this results in a value of 6 for "LengthIndicatorDigits" and the offset for the Q-data results in $512 + 6 = 518$.

A.2 Formats for Returned Values: ASCII Format and Binary Format

When trace data is retrieved using the `TRAC:DATA` or `TRAC:IQ:DATA` command, the data is returned in the format defined using the `FORMAt [:DATA]`. The possible formats are described here.

- **ASCII Format (FORMAt ASCII):**
The data is stored as a list of comma separated values (CSV) of the measured values in floating point format.
- **Binary Format (FORMAt REAL,32):**
The data is stored as binary data (Definite Length Block Data according to IEEE 488.2), each measurement value being formatted in 32 Bit IEEE 754 Floating-Point-Format.
The schema of the result string is as follows:
#41024<value1><value2>...<value n> with

#4	number of digits (= 4 in the example) of the following number of data bytes
1024	number of following data bytes (= 1024 in the example)
<Value>	4-byte floating point value



Reading out data in binary format is quicker than in ASCII format. Thus, binary format is recommended for large amounts of data.

A.3 Sample Rate and Maximum Usable I/Q Bandwidth for RF Input

Definitions

- **Input sample rate (ISR):** the sample rate of the useful data provided by the connected instrument to the R&S FSW input

Sample Rate and Maximum Usable I/Q Bandwidth for RF Input

- (User, Output) **Sample rate (SR)**: the sample rate that is defined by the user (e.g. in the "Data Acquisition" dialog box in the "I/Q Analyzer" application) and which is used as the basis for analysis or output
- **Usable I/Q (Analysis) bandwidth**: the bandwidth range in which the signal remains undistorted in regard to amplitude characteristic and group delay; this range can be used for accurate analysis by the R&S FSW
- **Record length**: Number of I/Q samples to capture during the specified measurement time; calculated as the measurement time multiplied by the sample rate

For the I/Q data acquisition, digital decimation filters are used internally. The passband of these digital filters determines the *maximum usable I/Q bandwidth*. In consequence, signals within the usable I/Q bandwidth (passband) remain unchanged, while signals outside the usable I/Q bandwidth (passband) are suppressed. Usually, the suppressed signals are noise, artifacts, and the second IF side band. If frequencies of interest to you are also suppressed, you should try to increase the output sample rate, since this increases the maximum usable I/Q bandwidth.



Bandwidth extension options

The maximum usable I/Q bandwidth provided by the R&S FSW in the basic installation can be extended by additional options. These options can either be included in the initial installation (B-options) or updated later (U-options). The maximum bandwidth provided by the individual option is indicated by its number, for example, B40 extends the bandwidth to 40 MHz.

Note that the U-options as of U40 always require all lower-bandwidth options as a prerequisite, while the B-options already include them.

Max. usable I/Q BW	Required B-option	Required U-option(s)
10 MHz	-	-
28 MHz	B28	U28
40 MHz	B40	U28+U40 or B28+U40
80 MHz	B80	U28+U40+U80 or B28+U40+U80 or B40+U80
160 MHz	B160	U28+U40+U80+U160 or B28+U40+U80+U160 or B40+U80+U160 or B80+U160
<p>*) The bandwidth extension option R&S FSW-B320/-U320 requires a reference board revision 3.14 or higher.</p> <p>**) The bandwidth extension option R&S FSW-B500 requires a reference board (1312.8075.06) revision 4.06 or higher and a motherboard 1313.4180.02 or 1313.7698.02.</p>		

Sample Rate and Maximum Usable I/Q Bandwidth for RF Input

Max. usable I/Q BW	Required B-option	Required U-option(s)
320 MHz	B320 ^{*)}	U28+U40+U80+U160+U320 or B28+U40+U80+U160+U320 or B40+U80+U160+U320 or B80+U160+U320 or B160+U320
500 MHz	B500 ^{**)}	See data sheet
<p>^{*)} The bandwidth extension option R&S FSW-B320/-U320 requires a reference board revision 3.14 or higher.</p> <p>^{**)} The bandwidth extension option R&S FSW-B500 requires a reference board (1312.8075.06) revision 4.06 or higher and a motherboard 1313.4180.02 or 1313.7698.02.</p>		

As a rule, the usable I/Q bandwidth is proportional to the output sample rate. Yet, when the I/Q bandwidth reaches the bandwidth of the analog IF filter (at very high output sample rates), the curve breaks.

Relationship between sample rate, record length and usable I/Q bandwidth

Up to the maximum bandwidth, the following rule applies:

$$\text{Usable I/Q bandwidth} = 0.8 * \text{Output sample rate}$$

Regarding the record length, the following rule applies:

$$\text{Record length} = \text{Measurement time} * \text{sample rate}$$

Maximum record length for RF input

The maximum record length, that is, the maximum number of samples that can be captured, depends on the sample rate.

(For activated option B320 or U320 see [table 1-3.](#))

(For activated option B500 see [table 1-4.](#))

Table 1-1: Maximum record length (without I/Q bandwidth extension options B320/U320/B500)

Sample rate	Maximum record length
100 Hz to 200 MHz	440 MSamples (precisely: 461373440 (= 440*1024*1024) samples)
200 MHz to 10 GHz (upsampling)	220 MSamples

The [figure 1-2](#) shows the maximum usable I/Q bandwidths depending on the output sample rates.

R&S FSW without additional bandwidth extension options

sample rate: 100 Hz - 10 GHz

maximum I/Q bandwidth: 10 MHz

Sample Rate and Maximum Usable I/Q Bandwidth for RF Input

Table 1-2: Maximum I/Q bandwidth

Sample rate	Maximum I/Q bandwidth
100 Hz to 10 MHz	proportional up to maximum 10 MHz
10 MHz to 10 GHz	10 MHz

R&S FSW with options B28 or U28 (I/Q Bandwidth Extension):

sample rate: 100 Hz - 10 GHz

maximum bandwidth: 28 MHz

Sample rate	Maximum I/Q bandwidth
100 Hz to 35 MHz	proportional up to maximum 28 MHz
35 MHz to 10 GHz	28 MHz

R&S FSW with option B40 or U40 (I/Q Bandwidth Extension):

sample rate: 100 Hz - 10 GHz

maximum bandwidth: 40 MHz

Sample rate	Maximum I/Q bandwidth
100 Hz to 50 MHz	proportional up to maximum 40 MHz
50 MHz to 10 GHz	40 MHz

R&S FSW with option B80 or U80 (I/Q Bandwidth Extension):

sample rate: 100 Hz - 10 GHz

maximum bandwidth: 80 MHz

Sample rate	Maximum I/Q bandwidth
100 Hz to 100 MHz	proportional up to maximum 80 MHz
100 MHz to 10 GHz	80 MHz

R&S FSW with activated option B160 or U160 (I/Q Bandwidth Extension):

sample rate: 100 Hz - 10 GHz

maximum bandwidth: 160 MHz

Sample rate	Maximum I/Q bandwidth
100 Hz to 200 MHz	proportional up to maximum 160 MHz
200 MHz to 10 GHz	160 MHz

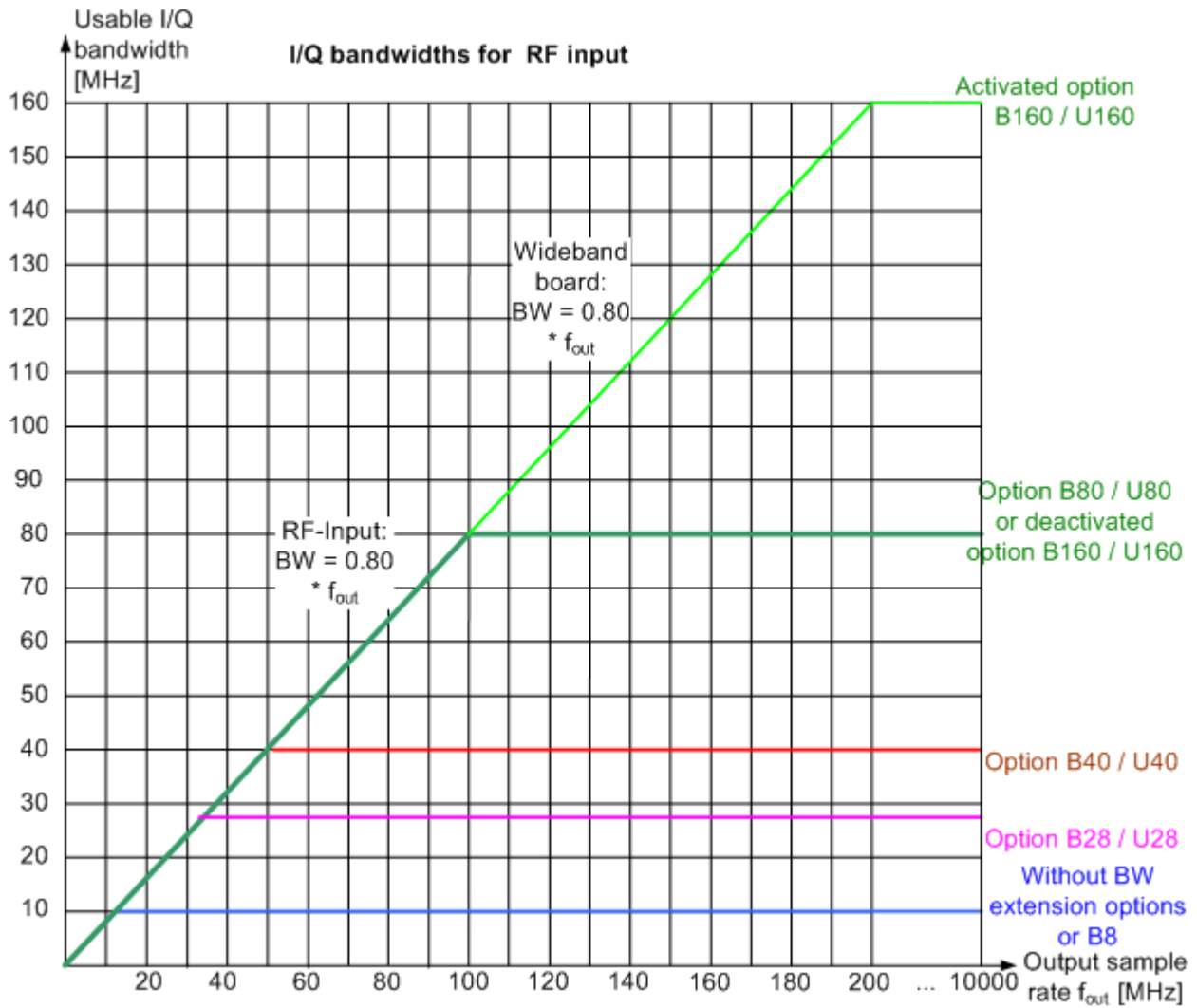

Fig. 1-2: Relationship between maximum usable I/Q bandwidth and output sample rate with and without bandwidth extensions

A.3.1 Max. Sample Rate and Bandwidth with Activated I/Q Bandwidth Extension Option B320/U320

Sample rate	Maximum I/Q bandwidth
100 Hz to 400 MHz	proportional up to maximum 320 MHz
400 MHz to 10 GHz	320 MHz

Sample Rate and Maximum Usable I/Q Bandwidth for RF Input

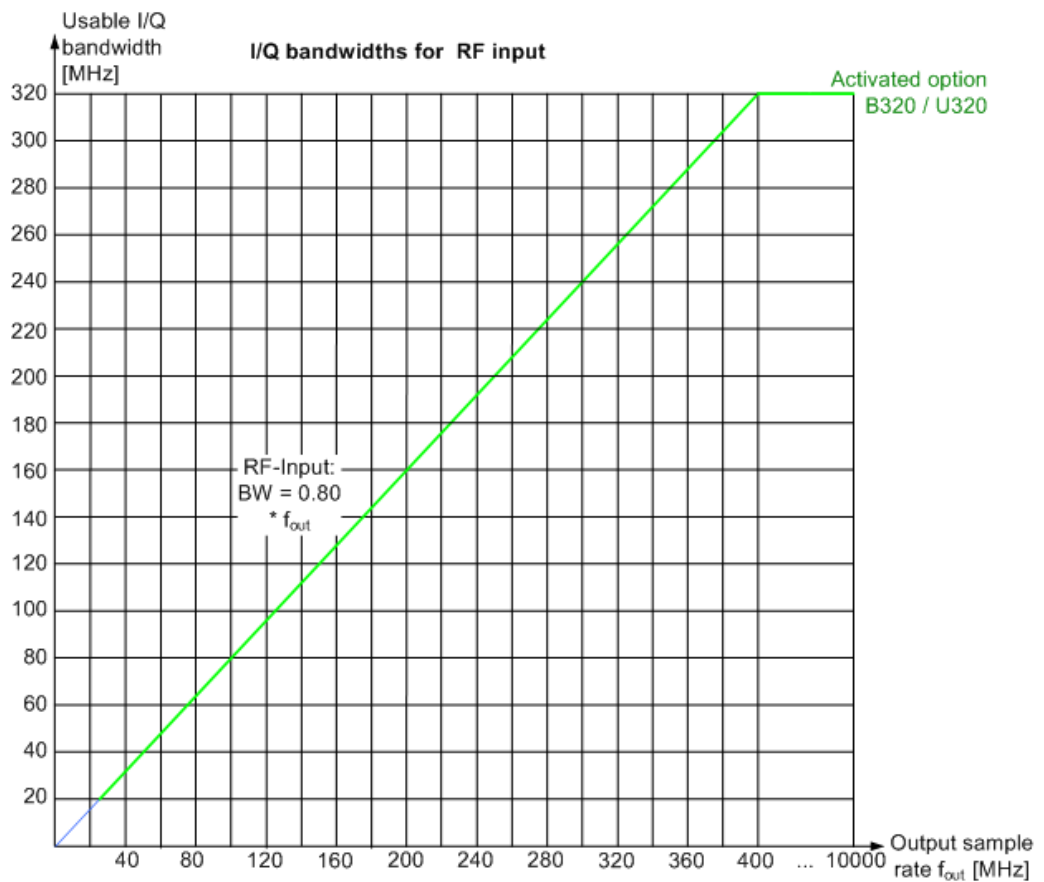

Fig. 1-3: Relationship between maximum usable I/Q bandwidth and output sample rate for active R&S FSW-B320

Table 1-3: Maximum record length with activated I/Q bandwidth extension option B320 or U320

Sample rate	Maximum record length
100 Hz to 200 MHz*)	440 MSamples
200 MHz to 468 MHz	470 MSamples * sample rate / 1GHz
468 MHz to 10 GHz	220 MSamples
*) for sample rates < 200 MHz the I/Q Bandwidth Extension B320 is not used	

A.3.2 Max. Sample Rate and Bandwidth with Activated I/Q Bandwidth Extension Option B500

The bandwidth extension option R&S FSW-B500 provides measurement bandwidths up to 500 MHz.

Sample rate	Maximum I/Q bandwidth
100 Hz to 600 MHz	proportional up to maximum 500 MHz
600 MHz to 10 GHz	500 MHz



Bandwidths between 480 MHz and 500 MHz

Note the irregular behavior of the sample rate/usable I/Q bandwidth relationship for bandwidths between 480 MHz and 500 MHz, depending on which setting you change. For compatibility reasons, the relationship of *Usable I/Q bandwidth = 0.8 * Output sample rate* is maintained for bandwidths ≤480 MHz.

However, in order to make use of the maximum possible sample rate of 600 MHz at the maximum bandwidth of 500 MHz, if you **change the bandwidth** between 480 MHz and 500 MHz, the sample rate is adapted according to the relationship *Output sample rate = Usable I/Q bandwidth/0.833*.

On the other hand, if you **decrease the sample rate** under 600 MHz, the I/Q bandwidth is adapted according to the regular relationship of *Usable I/Q bandwidth = 0.8 * Output sample rate*.

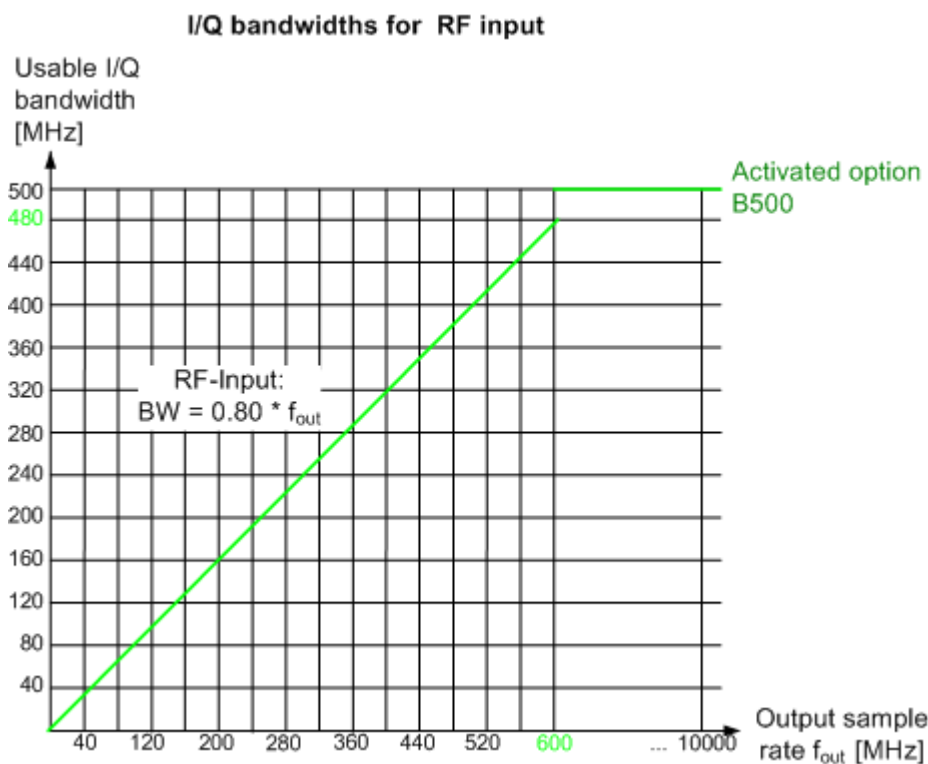

Fig. 1-4: Relationship between maximum usable I/Q bandwidth and output sample rate for active R&S FSW-B500

Table 1-4: Maximum record length with activated I/Q bandwidth extension option B500

Sample rate	Maximum record length
100 Hz to 10 GHz	440 MSamples

A.4 Sample Rates and Bandwidths for Digital I/Q Data

Definitions

- **Clock rate:** the rate at which data is physically transmitted between the R&S FSW and the connected instrument; both instruments must be able to process data at this rate; the clock rate of the R&S FSW at the output connector is 142.9 MHz; using the Digital I/Q enhanced mode, a data transfer rate of up to 200 Msps is possible
- **Input sample rate (ISR):** the sample rate of the useful data provided by the connected instrument to the digital input
- (User, Output) **Sample rate (SR):** the sample rate that is defined by the user (e.g. in the "Data Acquisition" dialog box in the "I/Q Analyzer" application) and which is used as the basis for analysis or sent to the digital output
- **Usable I/Q (Analysis) bandwidth:** the bandwidth range in which the signal remains unchanged by the digital decimation filter and thus remains undistorted; this range can be used for accurate analysis by the R&S FSW



Slow I/Q measurements

When captured data is transferred and further processed with a slower rate than the rate with which the signal was sampled, this is referred to as a *Slow I/Q measurement*. For example, assume an analog signal is sampled by an oscilloscope with a sample rate of 10 GHz. This data is stored in a memory temporarily and then transferred to the R&S FSW via the Digital I/Q Interface with a sample rate of 100 R&S FSW Msps. Then the input sample rate on the R&S FSW must be set to 10 GHz so the signal is displayed correctly.



Digital I/Q enhanced mode

As of firmware version 1.80, an enhanced mode for processing data from the Digital Baseband Interface is available. This enhanced mode enables data transfer via the Digital I/Q interface with a data rate of up to 200 Msps (160 MHz bandwidth, compared to the previous 100 Msps/ 80 MHz bandwidth).

The Digital I/Q enhanced mode is automatically used if the following prerequisites are fulfilled:

- **Digital Input:** The connected device must support data transfer rates up to 200 Msps.
- **Digital Output:**
 - The R&S FSW must supply the required bandwidth, i.e. the bandwidth extension option R&S FSW-B160 or higher must be installed and active.
 - The connected device must support data transfer rates up to 200 Msps.

Restrictions for digital in- and output

The following table describes the restrictions for digital in- and output:

Table 1-5: Restrictions for digital in- and output

Parameter	Minimum	Maximum
Record length	2 complex samples	220*1024*1024 complex samples
Input sample rate (ISR)	100 Hz	10 GHz
Sample Rate (SR) - Digital input	Max(100 Hz; ISR/8388608)	Min(10 GHz; 2*ISR)
Sample Rate (SR) - Digital output	100 Hz	200 MHz
Usable I/Q bandwidth (Digital input and filter active)	Min(0.8*SR; 0.8*ISR)	

Bandwidths

Depending on the sample rate, the following bandwidths are available:

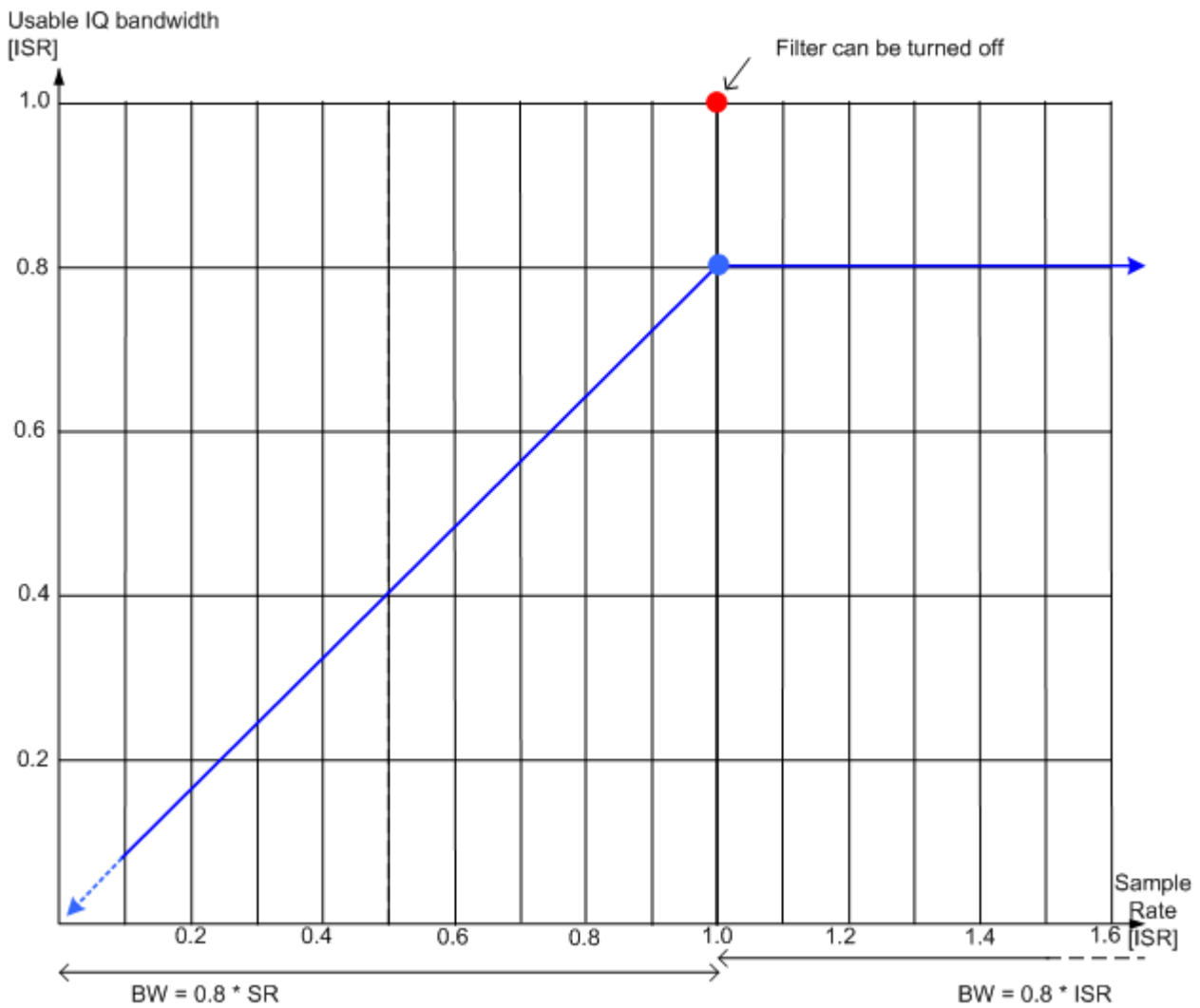

Fig. 1-5: Bandwidths depending on sample rate for active digital input

List of Remote Commands (MSRA)

[SENSe:]ADJust:ALL.....	129
[SENSe:]ADJust:CONFigure:DURation.....	130
[SENSe:]ADJust:CONFigure:DURation:MODE.....	130
[SENSe:]ADJust:CONFigure:HYSteresis:LOWer.....	131
[SENSe:]ADJust:CONFigure:HYSteresis:UPPer.....	131
[SENSe:]ADJust:FREQuency.....	131
[SENSe:]ADJust:LEVel.....	132
[SENSe:]FREQuency:CENTer.....	112
[SENSe:]FREQuency:CENTer:STEP.....	113
[SENSe:]FREQuency:CENTer:STEP:AUTO.....	113
[SENSe:]FREQuency:OFFSet.....	113
[SENSe:]IQ:BANDwidth BWIDth:MODE.....	123
[SENSe:]IQ:BANDwidth BWIDth:RESolution.....	123
[SENSe:]IQ:FFT:ALGorithm.....	124
[SENSe:]IQ:FFT:LENGth.....	124
[SENSe:]IQ:FFT:WINDow:LENGth.....	125
[SENSe:]IQ:FFT:WINDow:OVERlap.....	125
[SENSe:]IQ:FFT:WINDow:TYPE.....	125
[SENSe:]MSRA:CAPTure:OFFSet.....	146
[SENSe:]PROBe<p>:SETup:CMOFFset.....	103
[SENSe:]PROBe<p>:ID:PARTnumber?.....	104
[SENSe:]PROBe<p>:ID:SRNumber?.....	105
[SENSe:]PROBe<p>:SETup:MODE.....	105
[SENSe:]PROBe<p>:SETup:NAME?.....	106
[SENSe:]PROBe<p>:SETup:STATe?.....	106
[SENSe:]PROBe<p>:SETup:TYPE?.....	106
[SENSe:]SWEep:POINts.....	136
[SENSe:]SWEep:TIME.....	136
ABORT.....	133
CALCulate:IQ:MODE.....	145
CALCulate:MSRA:ALINe:SHOW.....	145
CALCulate:MSRA:ALINe[VALue].....	145
CALCulate:MSRA:WINDow<n>:IVAL?.....	145
CALCulate<n>:MARKer<m>:FUNCTion:REFerence.....	107
CALibration:AIQ:DCOFFset:I.....	102
CALibration:AIQ:DCOFFset:Q.....	102
DIAGnostic:SERVice:NSource.....	114
DISPlay[:WINDow<n>]:TRACe:Y:SPACing.....	111
DISPlay[:WINDow<n>]:TRACe:Y[:SCALe].....	110
DISPlay[:WINDow<n>]:TRACe:Y[:SCALe]:AUTO ONCE.....	111
DISPlay[:WINDow<n>]:TRACe:Y[:SCALe]:MODE.....	111
DISPlay[:WINDow<n>]:TRACe:Y[:SCALe]:RLEVel.....	107
DISPlay[:WINDow<n>]:TRACe:Y[:SCALe]:RLEVel:OFFSet.....	108
DISPlay[:WINDow<n>]:TRACe:Y[:SCALe]:RPOSition.....	111
FORMat[:DATA].....	138
INITiate:CONMeas.....	133
INITiate:CONTinuous.....	134

INITiate:REFResh.....	146
INITiate:SEQuencer:ABORT.....	134
INITiate:SEQuencer:IMMediate.....	135
INITiate:SEQuencer:MODE.....	135
INITiate:SEQuencer:REFResh[ALL].....	136
INITiate[:IMMediate].....	134
INPut:ATTenuation.....	108
INPut:ATTenuation:AUTO.....	108
INPut:ATTenuation:PROTection:RESet.....	94
INPut:CONNector.....	94
INPut:COUPling.....	95
INPut:DIQ:CDEvice.....	97
INPut:DIQ:RANGe:COUPling.....	99
INPut:DIQ:RANGe[:UPPer].....	99
INPut:DIQ:RANGe[:UPPer]:AUTO.....	98
INPut:DIQ:RANGe[:UPPer]:UNIT.....	99
INPut:DIQ:SRATe.....	100
INPut:DIQ:SRATe:AUTO.....	100
INPut:EATT.....	109
INPut:EATT:AUTO.....	109
INPut:EATT:STATe.....	109
INPut:FILTer:HPASs[:STATe].....	95
INPut:FILTer:YIG[:STATe].....	96
INPut:GAIN:STATe.....	110
INPut:GAIN[:VALue].....	110
INPut:IMPedance.....	96
INPut:IQ:BALanced[:STATe].....	101
INPut:IQ:FULLscale:AUTO.....	101
INPut:IQ:FULLscale[:LEVel].....	101
INPut:IQ:TYPE.....	102
INPut:SElect.....	96
INSTRument:CREate:DUPLicate.....	89
INSTRument:CREate:REPLace.....	90
INSTRument:CREate[:NEW].....	89
INSTRument:DELeTe.....	90
INSTRument:LIST?.....	90
INSTRument:MODE.....	91
INSTRument:REName.....	92
INSTRument[:SElect].....	92
OUTPut:IF:IFFRequency.....	114
OUTPut:TRIGger<port>:DIRection.....	120
OUTPut:TRIGger<port>:LEVel.....	121
OUTPut:TRIGger<port>:OTYPE.....	121
OUTPut:TRIGger<port>:PULSe:IMMediate.....	122
OUTPut:TRIGger<port>:PULSe:LENGth.....	122
STATus:OPERation:CONDition?.....	142
STATus:OPERation:ENABLE?.....	142
STATus:OPERation:NTRansition?.....	143
STATus:OPERation:PTRansition?.....	143
STATus:OPERation[:EVENT]?.....	143

SYSTem:PRESet:CHANnel[:EXECute].....	93
SYSTem:PRESet:COMPAtible.....	93
SYSTem:SEQuencer.....	137
TRACe:IQ:APCon:A.....	104
TRACe:IQ:APCon:B.....	104
TRACe:IQ:APCon:RESult?.....	104
TRACe:IQ:APCon[:STATe].....	103
TRACe:IQ:BWIDth.....	126
TRACe:IQ:DATA:FORMat.....	139
TRACe:IQ:DATA:MEMory?.....	139
TRACe:IQ:DATA?.....	138
TRACe:IQ:RLENGth.....	126
TRACe:IQ:SRATe.....	127
TRACe:IQ:TPISample?.....	127
TRACe:IQ:WBANd:MBWIDTh.....	128
TRACe:IQ:WBANd[:STATe].....	128
TRIGger[:SEQuence]:BBPower:HOLDoff.....	115
TRIGger[:SEQuence]:DTIME.....	115
TRIGger[:SEQuence]:HOLDoff[:TIME].....	116
TRIGger[:SEQuence]:IFPower:HOLDoff.....	116
TRIGger[:SEQuence]:IFPower:HYSteresis.....	116
TRIGger[:SEQuence]:LEVel:BBPower.....	116
TRIGger[:SEQuence]:LEVel:IFPower.....	117
TRIGger[:SEQuence]:LEVel:IQPower.....	117
TRIGger[:SEQuence]:LEVel:RFPower.....	118
TRIGger[:SEQuence]:LEVel[:EXTernal<port>].....	117
TRIGger[:SEQuence]:SLOPe.....	118
TRIGger[:SEQuence]:SOURce.....	118
TRIGger[:SEQuence]:TIME:RINTerval.....	120

Index

Symbols

*OPC	114
1xEV-DO BTS	
MSRA application	23
3G FDD BTS	
MSRA application	22

A

Aborting	
Sweep	63, 64
AC/DC coupling	36
Activating	
MSRA (remote)	89
Active probe	
Microbutton	42
Amplitude	
Analog Baseband Interface (B71) settings	46
Configuration (softkey)	43
Scaling	48
Settings	43
Analog Baseband	
Amplitude settings	46
Input	37
Input settings	40
Analog Baseband (B71)	
Full scale level	47
I/Q mode	41
Input type (remote control)	102
Analog Baseband Interface (B71)	
Amplitude settings	46
Input settings	40
Analog Demodulation	
MSRA application	21
Analysis	
Bandwidth	59
Bandwidth, definition	150, 157
Settings	70
Analysis interval	28
Configuration	70
Configuration (remote)	144
I/Q Analyzer	58, 70
Start	29
Analysis line	29
Configuration	70
Application data	28
Availability	27
Configuration (remote)	144
Coverage	12, 14
Restrictions	29
Results	14
Settings	26
Start	29
Applications	
Pulse	21
see MSRA applications	19
Transient Analysis	22
AQT	
Displayed	13
Attenuation	44
Auto	44
Displayed	13

Electronic	45
Manual	44
Option B25	45
Protective (remote)	94
Auto all	
Softkey	67
Auto frequency	
Softkey	67
Auto level	
Hysteresis	68, 69
Reference level	68
Softkey	68
Auto settings	
Meastime Auto (softkey)	68
Meastime Manual (softkey)	68
MSRA Master	67
Remote	129

B

Bandwidth	
Analysis	59
depending on sample rate	158
Digital I/Q data	157
Extension	59
Extension options	151, 152
Maximum	59
Maximum usable	150
Relationship to sample rate	152
Settings	57
BB Power	
Trigger (softkey)	53

C

Capture buffer	28
Capture finished	
Status bit	141
Capture offset	29
MSRA applications	62
Remote	146
Softkey	62
Capture time	
see also Measurement time	136
cdma2000 BTS	
MSRA application	22
Center frequency	50
Analog Baseband (B71)	41
Automatic configuration	67
Softkey	50
Step size	50
Channel-defined Sequencer	
Softkey	25
Channels	
New	24
Operating modes	19
Replacing	24
Clock rate	
Definition	157
Closing	
Channels (remote)	90
Configuration	
MSRA mode	32

Continue single sweep	
Softkey	64
Continuous Sequencer	
Softkey	25
Continuous sweep	
Softkey	63
Conventions	
SCPI commands	84
Copying	
Measurement channel (remote)	89
Coupling	
Input (remote)	95

D

Data acquisition	17
Analysis interval	58
Basics	27
Performing (remote)	132
Procedure	72
Settings	57
Settings (remote)	122
Softkey	57
Status bit	141
Data format	
ASCII	150
Binary	150
Remote	138
DC offset	
Analog Baseband (B71, remote control)	102
Default values	
Preset	33
Diagram area	
Displayed	13
Diagram footer information	11
Differential input	
Analog Baseband (B71, remote control)	101
Analog Baseband (B71)	41
DigIConf	
Softkey, see also R&S DigIConf	39
Digital Baseband Interface (B17)	
Input settings	38
Input status (remote)	97
Digital I/Q	
Bandwidths	157
Enhanced mode	53, 157
Input connection information	39
Input settings	38
Sample rates	157
Triggering	53
Digital input	
Bandwidths	158
Connection information	39
Restrictions	158
Digital output	
Restrictions	158
Display configuration	
Softkey	67
Display elements	
MSRA	10
Drop-out time	
Trigger	55
Duplicating	
Measurement channel (remote)	89

E

Electronic input attenuation	44, 45
Enhanced mode	
Digital I/Q	53, 157
Errors	
IF OVLD	44, 46
Exporting	
I/Q data	70
External trigger	
Level (remote)	117
Softkey	53

F

FFT	
Window functions	61
Filters	
Bandwidth, I/Q data	59
High-pass (remote)	95
High-pass (RF input)	37
YIG (remote)	96
Format	
Data	150
Data (remote)	138
I/Q data files	149
Free Run	
Trigger (softkey)	53
Frequency	
Configuration (remote)	112
Configuration (softkey)	49
Frequency offset	50
Frontend settings	
Remote	94
Full scale level	
Analog Baseband (B71, remote control)	101
Analog Baseband (B71)	47
Digital I/Q	39
Digital I/Q (remote)	98, 99
Unit, digital I/Q (remote)	99

G

GSM	
MSRA application	21

H

Hardware settings	
Display	13
Displayed	13
High-pass filter	
Remote	95
RF input	37
Hysteresis	
Lower (Auto level)	69
Trigger	56
Upper (Auto level)	68

I

I/Q Analyzer	
Analysis interval	70
MSRA application	21
MSRA Master	17, 144

- I/Q data
 - Analyzing 73
 - Availability 27
 - Capturing 72
 - Exporting 70
 - File format description 149
 - Maximum bandwidth 150
 - Measurements in time and frequency domain 30
 - Sample rate 150
 - trigger point in sample (TPIS) 127
- I/Q Power
 - Trigger (softkey) 54
 - Trigger level (remote) 117
- I/Q Vector
 - Y-axis scaling 49
- IF Power
 - Trigger level (remote) 117
- IF WIDE OUTPUT
 - Connector 59
- Impedance
 - Remote 96
 - Setting 37
- Input
 - Analog Baseband Interface (B71) settings 40
 - Connector (remote) 94
 - Coupling 36
 - Coupling (remote) 95
 - Digital Baseband Interface (B17) settings 38
 - Overload (remote) 94
 - Settings 35, 45
 - Source Configuration (softkey) 35
 - Source, Analog Baseband 40
 - Source, digital I/Q 38
 - Source, Radio frequency (RF) 36
- Input sample rate (ISR)
 - Definition 150, 157
 - Digital I/Q 38
- Input settings
 - Remote 94
- IQBlock
 - I/Q data files 149
- IQPair
 - I/Q data files 149
- K**
- Keys
 - LINES (not used) 32
 - RUN CONT 63
 - RUN SINGLE 64
- L**
- Lower Level Hysteresis
 - Softkey 69
- M**
- Measurement channel
 - Creating (remote) 89, 90, 91, 92
 - Deleting (remote) 90
 - Duplicating (remote) 89
 - Querying (remote) 90
 - Renaming (remote) 92
 - Replacing (remote) 90
 - Selecting (remote) 91, 92
- Measurement examples
 - MSRA mode 75
- Measurement time
 - Auto settings 68
 - I/Q data 59
 - Remote 136
- Measurements
 - Activating (remote) 89
 - Analyzing 144
 - Configuring (remote) 94
 - Correlating 19
 - Default values 33
 - Result displays 17
- Microbutton
 - Probes 42
- Modes
 - see Operating mode 19
- MSRA applications 19
 - 1xEV-DO BTS 23
 - 3G FDD BTS 22
 - Analog Demodulation 21
 - Analysis interval (remote) 144
 - Analyzing I/Q data 73
 - Available 20
 - Capture offset 62
 - Capture offset (remote) 146
 - cdma2000 BTS 22
 - Display elements 14
 - GSM 21
 - I/Q Analyzer 21
 - Parameters 26
 - Restrictions 29
 - Selecting 23
 - Specific commands (remote) 144
 - TD-SCDMA BTS 22
 - Vector Signal Analysis (VSA) 22
- MSRA Master
 - Analyzing 70
 - Capturing data 72
 - Configuring 32
 - Data acquisition 57
 - Data acquisition (basics) 27
 - Data acquisition (remote) 122
 - Display elements 13
 - Parameters 26
 - Results display 17
 - Selecting (remote) 89
 - Tab 13
 - Trigger offset 55
 - Trigger settings 51
- MSRA mode
 - Remote control 83
- MSRA View 73
 - Display elements 12
 - Tab 12
- Multi-standard
 - Analysis 73
 - Radio Base Station (MSR-BS) 16
- N**
- Noise
 - Source 65

- O**
- Offset
 - Analysis interval 62
 - Frequency 50
 - Reference level 44, 47
 - Reference level, displayed 13
 - Operating mode 19
 - Changing 20
 - MSRA (remote) 89
 - Selecting 23
 - Starting 9
 - Options
 - B160 59
 - Bandwidth extension 59, 151, 152
 - Electronic attenuation (B25) 45
 - High-pass filter (B13) 37, 95
 - Preamplifier (B24) 45
 - U160 59
 - Output
 - Configuration (remote) 114
 - Configuration (softkey) 65
 - IF frequency (remote) 114
 - Noise source 65
 - Sample rate, definition 150, 157
 - Settings 65
 - Settings (remote) 94
 - Trigger 56, 65
 - Overload
 - RF input (remote) 94
 - Overview
 - Configuration 34
- P**
- Parameters
 - Conflicting 26
 - MSRA applications 26
 - MSRA Master 26
 - Passing between applications 20
 - Performing
 - MSRA measurement 72
 - Power sensors
 - Trigger mode 54
 - Pre-trigger 55
 - Preamplifier
 - Setting 45
 - Softkey 45
 - Presetting
 - Channels 35
 - Default values 33
 - Probes
 - Microbutton 42
 - Settings 42
 - Programming examples
 - MSRA mode 147
 - Protection
 - RF input (remote) 94
 - Pulse
 - Application 21
- R**
- R&S DiglConf 39
 - R&S EX-IQ-BOX
 - DiglConf 39
 - R&S SMBV
 - Measurement example 75
 - R&S SMU
 - Measurement example 75
 - Range 48
 - RBW
 - Displayed 13
 - Ready for trigger
 - Status register 141
 - Record length
 - Definition 150
 - Displayed 13
 - I/Q data 60
 - Relationship to sample rate 152
 - Reference level
 - Auto level 68
 - Digital I/Q 39
 - Displayed 13
 - Offset 44, 47
 - Offset (softkey) 44, 47
 - Position 48
 - Softkey 44, 46
 - Unit 44, 46
 - Value 44, 46
 - Refreshing 25
 - All applications (softkey) 25
 - MSRA applications 63
 - MSRA applications (remote) 146
 - MSRT applications (remote) 146
 - Result display 27
 - Softkey 63
 - Remote commands
 - Basics on syntax 83
 - Boolean values 87
 - Capitalization 85
 - Character data 88
 - Data blocks 88
 - Numeric values 86
 - Optional keywords 85
 - Parameters 86
 - Strings 88
 - Suffixes 85
 - Repetition interval 55
 - Softkey 55
 - Resetting
 - RF input protection 94
 - Restoring
 - Channel settings 35
 - Restrictions
 - MSRA applications 29
 - Results
 - Analyzing 70
 - Data format (remote) 138
 - Display, MSRA Master 17
 - Retrieving (remote) 137
 - Updating the display 63
 - Updating the display (remote) 146
 - RF attenuation
 - Auto (softkey) 44
 - Manual (softkey) 44
 - RF input 36
 - Connector (remote) 94
 - Overload protection (remote) 94
 - Remote 94, 96
 - RF Power
 - Trigger 54
 - Trigger level (remote) 118

- RUN CONT
 - Key 63
- RUN SINGLE
 - Key 64
- S**
- Sample rate
 - Definition 150, 157
 - Digital I/Q 38
 - Digital I/Q (remote) 100
 - Digital I/Q data 157
 - Displayed 13
 - I/Q data 58
 - Maximum 150
 - Relationship to bandwidth 152
 - Remote 127
- Scaling
 - Configuration (softkey) 47
 - Y-axis 48
 - Y-axis (remote control) 111
- Sequencer
 - Aborting (remote) 134
 - Activating (remote) 135
 - Continuous sweep 24
 - Mode 25
 - Mode (remote) 135
 - MSRA mode 9, 24
 - Remote 134
 - Result display 24
 - Softkey 25
 - State 25
- Signal capturing
 - Duration (remote) 136
- Signal source
 - Remote 96
- Single Sequencer
 - Softkey 25
- Single sweep
 - Softkey 64
- Slope
 - Trigger 56, 118
- Slow/I/Q 157
- SMx 75
- Softkeys
 - Amplitude Config 43
 - Auto All 67
 - Auto Freq 67
 - Auto Level 68
 - BB Power 53
 - Capture Offset 62
 - Center 50
 - Channel-defined Sequencer 25
 - Continue Single Sweep 64
 - Continuous Sequencer 25
 - Continuous Sweep 63
 - Data Acquisition 57
 - DigiConf 39
 - Digital I/Q 53
 - Display Config 67
 - External 53
 - Free Run 53
 - Frequency Config 49
 - I/Q Power 54
 - Input Source Config 35
 - Lower Level Hysteresis 69
 - Meastime Auto 68
 - Meastime Manual 68
 - Outputs Config 65
 - Power Sensor 54
 - Preamp 45
 - Ref Level 44, 46
 - Ref Level Offset 44, 47
 - Refresh 63
 - Refresh All 25
 - Repetition interval 55
 - RF Atten Auto 44
 - RF Atten Manual 44
 - RF Power 54
 - Scale Config 47
 - Sequencer 25
 - Single Sequencer 25
 - Single Sweep 64
 - Trigger Config 51
 - Trigger Offset 55
 - Upper Level Hysteresis 68
- Specifics for
 - Configuration 35
- SRate
 - see Sample rate 13
- Standards
 - Multiple, analyzing 16
- Status
 - Capture finished 141
- Status bar 12
- Status registers
 - Querying (remote) 141
 - STAT:QUES:POW 94
 - STATUS:OPERation 141
 - STATUS:OPERation 27
- Suffixes
 - Common 88
 - Remote commands 85
- Sweep
 - Aborting 63, 64
 - MSRA 27
 - Performing (remote) 132
 - Points (I/Q Analyzer) 63
 - Settings 62
 - Time (remote) 136
- Sweep status
 - Status register 141
- T**
- Tabs
 - Channels 19
 - MSRA Master 13
 - MSRA View 12
- TD-SCDMA BTS
 - MSRA application 22
- Time trigger
 - Repetition interval 55
- TPIS
 - I/Q data 127
- Traces
 - Maximum number 88
 - Retrieving data (remote) 137
- Transient Analysis
 - Application 22
- Trigger
 - Configuration (softkey) 51
 - Drop-out time 55
 - External (remote) 118

Holdoff	56
Hysteresis	56
Level	55
Offset	29
Offset (softkey)	55
Output	56, 65
Remote control	114
Slope	56, 118
Source	52
Status register	141
Trigger level	
External trigger (remote)	117
I/Q Power (remote)	117
IF Power (remote)	117
RF Power (remote)	118
Trigger source	52
BB Power	53
Digital I/Q	53
External	53
Free Run	53
I/Q Power	54
Power Sensor	54
RF Power	54
Troubleshooting	
Input overload	94
U	
Units	
Reference level	44, 46
Updating	
Result display	63
Result display (remote)	146
Upper Level Hysteresis	
Softkey	68
Usable I/Q bandwidth	
Definition	150, 157
User manuals	6
User sample rate	
Definition	150, 157
V	
VSA (Vector Signal Analysis)	
MSRA application	22
W	
Waiting for trigger	
Status register	141
Window title bar information	11
Windows	
Configuring	35
Maximum number	88
Y	
Y-axis	
Scaling	48
Scaling (I/Q Vector)	49
Settings	47
YIG-preselector	
Activating/Deactivating	37
Activating/Deactivating (remote)	96